

MATHEMATICAL MONOGRAPHS

EDITED BY

MANSFIELD MERRIMAN AND ROBERT S. WOODWARD

No. 18

ELLIPTIC INTEGRALS

BY

HARRIS HANCOCK

PROFESSOR OF MATHEMATICS IN THE UNIVERSITY OF CINCINNATI

FIRST EDITION

FIRST THOUSAND

NEW YORK

JOHN WILEY & SONS, INC.

LONDON: CHAPMAN & HALL, LIMITED

1917

COPYRIGHT, 1917
BY
HARRIS HANCOCK

PRESS OF
BRAUNWORTH & CO.
BOOK MANUFACTURERS
BROOKLYN, N. Y.

CONTENTS

	PAGE
INTRODUCTION.....	5
CHAPTER I	
ELLIPTIC INTEGRALS OF THE FIRST, SECOND, AND THIRD KINDS. THE LEGENDRE TRANSFORMATIONS.....	9
CHAPTER II	
THE ELLIPTIC FUNCTIONS.....	24
CHAPTER III	
ELLIPTIC INTEGRALS OF THE FIRST KIND REDUCED TO LEGENDRE'S NORMAL FORM.....	41
CHAPTER IV	
NUMERICAL COMPUTATION OF THE ELLIPTIC INTEGRALS OF THE FIRST AND SECOND KINDS. LANDEN'S TRANSFORMATIONS.....	65
CHAPTER V	
MISCELLANEOUS EXAMPLES AND PROBLEMS.....	88
CHAPTER VI	
FIVE-PLACE TABLES.....	92
INDEX.....	103

INTRODUCTION

THE editors of the present series of mathematical monographs have requested me to write a work on elliptic integrals which "shall relate almost entirely to the three well-known elliptic integrals, with tables and examples showing practical applications, and which shall fill about one hundred octavo pages." In complying with their request, I shall limit the monograph to what is known as the Legendre-Jacobi theory; and to keep the work within the desired number of pages I must confine the discussion almost entirely to what is known as the elliptic integrals of the first and second kinds.

In the elementary calculus are found methods of integrating any rational expression involving under a square root sign a quadratic in one variable; in the present work, which may be regarded as a somewhat more advanced calculus, we have to integrate similar expressions where cubics and quartics in one variable occur under the root sign. Whatever be the nature of these cubics and quartics, it will be seen that the integrals may be transformed into standard normal forms. Tables are given of these normal forms, so that the integral in question may be calculated to any degree of exactness required.

With the trigonometric sine function is associated its inverse function, an integral; and similarly with the normal forms of elliptic integrals there are associated elliptic functions. A short account is given of these functions which emphasizes their doubly periodic properties. By making suitable transformations and using the inverse of these functions, it is found that the integrals in question may be expressed more concisely through the normal forms and in a manner that indicates the transformation employed.

The underlying theory, the philosophy of the subject, I have attempted to give in my larger work on elliptic functions, Vol. I. In the preparation of the present monograph much use has been made of Greenhill's *Application of Elliptic Functions*, a work which cannot be commended too highly; one may also read with great advantage Cayley's *Elliptic Functions*. The standard works of Legendre, Abel and Jacobi are briefly considered in the text. It may also be of interest to note briefly the earlier mathematicians who made possible the writings just mentioned.

The difference of two arcs of an ellipse that do not overlap may be expressed through the difference of two lengths on a straight line; in other words, this difference may be expressed in an *algebraic* manner. This is the geometrical signification of a theorem due to an Italian mathematician, Fagnano, which theorem is published in the twenty-sixth volume of the *Giornale de' letterari d'Italia*, 1716, and later with numerous other mathematical papers in two volumes under the title *Produzioni matematiche del Marchese Giulio Carlo de' Toschi di Fagnano*, 1750.

The great French mathematician Hermite (*Cours*, rédigé par Andoyer, Paris, 1882) writes "*Ce résultat doit être cité avec admiration comme ayant ouvert le premier la voie à la théorie des fonctions elliptiques.*"

Maclaurin in his celebrated work *A Treatise on Fluxions*, Edinburgh, 1742, Vol. II, p. 745, shows "how the *elastic curve* may be constructed in all cases by the rectification of the conic sections." On p. 744 he gives Jacob Bernoulli "as the celebrated author who first resolved this as well as several other curious problems" (see *Acta Eruditorium*, 1694, p. 274). It is thus seen that the elliptic integrals made their appearance in the formative period of the integral calculus.

The results that are given in Maclaurin's work were simplified and extended by d'Alembert in his treatise *Recherches sur le calcul intégral. Histoire de l'Ac. de Berlin, Année 1746*, pp. 182-224. The second part of this work, *Des différentielles qui se rapportent à la rectification de l'ellipse ou de l'hyperbole*,

treats of a number of differentials whose integrals through simple substitutions reduce to the integrals through which the arc of an ellipse or hyperbola may be expressed.

It was also known through the works of Fagnano, Jacob Bernoulli and others that the expressions for $\sin(\alpha + \beta)$, $\sin(\alpha - \beta)$ etc., gave a means of adding or subtracting the arcs of circles, and that between the limits of two integrals that express lengths of arc of a lemniscate an algebraic relation exists, such that the arc of a lemniscate, although a transcendent of higher order, may be doubled or halved just as the arc of a circle by means of geometric construction.

It was natural to inquire if the ellipse, hyperbola, etc., did not have similar properties. Investigating such properties, Euler made the remarkable discovery of the addition-theorem of elliptic integrals (see *Nov. Comm. Petrop.*, VI, pp. 58-84, 1761; and VII, p. 3; VIII, p. 83). A direct proof of this theorem was later given by Lagrange and in a manner which elicited the great admiration of Euler (see Serret's *Œuvres de Lagrange*, T. II, p. 533).

The addition-theorem for elliptic integrals gave to the elliptic functions a meaning in higher analysis similar to that which the cyclometric and logarithmic functions had enjoyed for a long time.

I regret that space does not permit the derivation of these addition-theorems and that the reader must be referred to a larger work.

The above mathematicians are the ones to whom Legendre refers in the introduction of his *Traité des fonctions elliptiques*, published in three quarto volumes, Paris, 1825. This work must always be regarded as the foundation of the theory of elliptic integrals and their associated functions; and Legendre must be regarded as the founder of this theory, for upon his investigations were established the doubly periodic properties of these functions by Abel and Jacobi and indeed in the very form given by Legendre. Short accounts of these theories are found in the sequel.

For more extended works the reader is referred to Appell

et Lacour, *Fonctions elliptiques*, and to Enneper, *Elliptische Funktionen*, where in particular the historical notes and list of authors cited on pp. 500–598 are valuable. Fricke in the article “*Elliptische Funktionen*,” *Encyclopädie der mathematischen Wissenschaften*, Vol. II, gives a fairly complete list of books and monographs that have been written on this subject.

To Dr. Mansfield Merriman I am indebted for suggesting many of the problems of Chapter V and also for valuable assistance in editing this work. I have pleasure also in thanking my colleague, Dr. Edward S. Smith, for drawing the figures carefully to scale.

HARRIS HANCOCK.

2365 Auburn Ave.,
CINCINNATI, OHIO,
October 3, 1916.

ELLIPTIC INTEGRALS

CHAPTER I

ELLIPTIC INTEGRALS OF THE FIRST, SECOND AND THIRD KINDS. THE LEGENDRE TRANSFORMATION

Art. 1. In the elementary calculus are studied such integrals as $\int \frac{dx}{s}$, $\int \frac{x dx}{(ax+b)s}$, etc., where $s^2 = ax^2 + 2bx + c$. In general the integral of any rational function of x and s can be transformed into other typical integrals, which are readily integrable. Such types of integrals are

$$\int^x \frac{dx}{\sqrt{1-x^2}}, \int_0^1 \frac{dx}{\sqrt{1-x^2}}, \int_0^x \frac{dx}{\sqrt{x^2+1}}, \text{ etc.}$$

In the present theory instead of, as above, writing s^2 equal to a quadratic in x , we shall put s^2 equal to a cubic or quartic in x . Suppose further that $F(x, s)$ is any rational function of x and s and consider the integral $\int F(x, s)dx$. Such an integral may be made to depend upon three types of integral of the form

$$\int \frac{dx}{s}, \int \frac{x^2 dx}{s} \text{ and } \int \frac{dx}{(x-b)s}.$$

These three types of integral, in somewhat different notation, were designated by Legendre, the founder of this theory, as elliptic integrals of the *first*, *second*, and *third kinds* respectively, while the general term "elliptic integral" was given by him to any integral of the form $\int F(x, s)dx$. The method of expressing the general integral through the three types of inte-

gral as first indicated by Legendre, may be found in my *Elliptic Functions*, Vol. I, p. 180.

Art. 2. First consider integrals of the form

$$\int \frac{c^2 x}{\sqrt{R(x)}}, \quad \dots \dots \dots (1)$$

which, as will be shown, reduce to a definite typical normal form,* when $R(x)$ is either of the third or fourth degree in x .

Suppose that $R(x)$ is of the fourth degree, and write

$$R(x) = a_0 x^4 + a_1 x^3 + a_2 x^2 + a_3 x + a_4,$$

where a_0, a_1, \dots , are real constants. It is seen that (1) may be written

$$\frac{1}{\sqrt{a_0}} \int \frac{dx}{\sqrt{X}}, \quad \dots \dots \dots (2)$$

where X , when decomposed into its factors, is

$$X = \pm(x-\alpha)(x-\beta)(x-\gamma)(x-\delta),$$

and $\sqrt{a_0}$ is a real quantity. If the roots are all real, suppose that $\alpha > \beta > \gamma > \delta$; if two are complex, take α and β real and write $\gamma = \rho + i\sigma$, $\delta = \rho - i\sigma$, where $i = \sqrt{-1}$; and if all four of the roots are complex, denote them by $\alpha = \mu + i\nu$, $\beta = \mu - i\nu$, $\gamma = \rho + i\sigma$, $\delta = \rho - i\sigma$.

In the present work the variable is taken real unless it is stated to the contrary or is otherwise evident.

We shall first so transform the expression X that only *even* powers of the variable appear. With Legendre (loc. cit., p. 7), write

$$x = \frac{p+qy}{1+y}. \quad \dots \dots \dots (3)$$

It follows at once that

$$\frac{dx}{\sqrt{X}} = \frac{(q-p)dy}{\sqrt{\pm Y}}, \quad \dots \dots \dots (4)$$

* See Legendre, *Traité des fonctions elliptiques*, T I, p. 11, et seq.; Richelot, *Crelle*, Bd. 34, p. 1; Enneper, *Elliptische Functionen*, p 14.

where

$$Y = [p - \alpha + (q - \alpha)y][p - \beta + (q - \beta)y][p - \gamma + (q - \gamma)y][p - \delta + (q - \delta)y]. \tag{5}$$

As all the results must be real, it will be seen that real values may be given to p and q in such a way that only even powers of y appear on the right-hand side of (5). If in this expression we multiply the first and second factors together, we have

$$(p - \alpha)(p - \beta) + (q - \alpha)(q - \beta)y^2$$

provided

$$(p - \alpha)(q - \beta) + (p - \beta)(q - \alpha) = 0; \dots \tag{6}$$

and similarly if

$$(p - \gamma)(q - \delta) + (p - \delta)(q - \gamma) = 0, \dots \tag{7}$$

the product of the third and fourth factors of (5) is

$$(p - \gamma)(p - \delta) + (q - \gamma)(q - \delta)y^2.$$

From (6) and (7) it follows that

$$pq + \alpha\beta = \frac{p+q}{2}(\alpha + \beta),$$

and

$$pq + \gamma\delta = \frac{p+q}{2}(\gamma + \delta).$$

From the last two equations, it also follows that

$$\frac{p+q}{2} = \frac{\alpha\beta - \gamma\delta}{\alpha + \beta - \gamma - \delta}, \quad pq = \frac{\alpha\beta(\gamma + \delta) - \gamma\delta(\alpha + \beta)}{\alpha + \beta - \gamma - \delta}. \tag{8}$$

From (8) it is seen that the sum and ^{quotient} of p and q are real quantities whatever the nature of the four roots α , β , γ , and δ may be; and further from (8) it is seen that

$$\left(\frac{q-p}{2}\right)^2 = \frac{(\alpha - \gamma)(\alpha - \delta)(\beta - \gamma)(\beta - \delta)}{(\alpha + \beta - \gamma - \delta)^2}, \dots \tag{9}$$

which is always a positive quantity. It follows that $q - p$ is a real quantity, and that p and q are real.

The equations (8) and (9) cannot be used if $\alpha + \beta = \gamma + \delta$.

In this case, as is readily shown, instead of the substitution (3), we may write

$$x = y + \frac{\alpha + \beta}{2} = y + \frac{\gamma + \delta}{2}.$$

It follows that (5) takes the form

$$Y = (\pm m^2 \pm n^2 y^2)(\pm r^2 \pm l^2 y^2),$$

where m , n , r , and l are real quantities.

The expression (4) then becomes

$$\frac{dx}{\sqrt{X}} = \frac{(q-p)dy}{\sqrt{\pm Y}} = \frac{dy}{f\sqrt{\pm(\pm 1 \pm g^2 y^2)(\pm 1 \pm h^2 y^2)}}, \quad \dots \quad (10)$$

where f , g , and h are essentially real quantities.

In the expression on the right-hand side, suppose that $h > g$ and put $hy = t$, and $\frac{g}{h} = c$, where $c < 1$.

It follows that

$$\frac{dx}{\sqrt{X}} = \frac{dt}{fh\sqrt{\pm(\pm 1 \pm t^2)(\pm 1 \pm c^2 t^2)}}. \quad \dots \quad (11)$$

It is seen that under the radical there are eight combinations of sign. With Legendre, loc. cit., Chap. II, and *Enneper*, p. 17, a table will be given below from which it is seen that the corresponding functions may be expressed by means of trigonometric substitutions in the one normal form

$$\frac{dx}{\sqrt{X}} = \pm \frac{1}{M} \frac{d\phi}{\sqrt{1 - k^2 \sin^2 \phi}} = \pm \frac{1}{M} \frac{dv}{\sqrt{(1-v^2)(1-k^2 v^2)}}, \quad (12)$$

where M is a *real* quantity and $v = \sin \phi$.

The quantity k , called the *modulus*, is also real, and situated within the interval $0 \leq k \leq 1$.

Of the expressions under the root sign $\sqrt{-(1+t^2)(1+c^2 t^2)}$ may be neglected, since $R(x)$, assumed^{*} to be positive for at least some real value of the original x , cannot be transformed into a function that is always negative by a real substitution.

Art. 3. Writing $\Delta\phi = \sqrt{1 - k^2 \sin^2 \phi}$ and defining the *com-*

plementary modulus k' by the relation $k^2 + k'^2 = 1$, the following table results:

I.	$\frac{dt}{\sqrt{(1+t^2)(1+c^2t^2)}} = \frac{d\phi}{\Delta\phi'}$	$t = \tan \phi,$	$k^2 = 1 - c^2$
II.	$\frac{dt}{\sqrt{(1-t^2)(1+c^2t^2)}} = \frac{-k'd\phi}{\Delta\phi'}$	$t = \cos \phi,$	$k^2 = \frac{c^2}{1+c^2}$
III.	$\frac{dt}{\sqrt{(t^2-1)(1+c^2t^2)}} = \frac{k d\phi}{\Delta\phi'}$	$t = \sec \phi,$	$k^2 = \frac{1}{1+c^2}$
IV.	$\frac{dt}{\sqrt{(1+t^2)(1-c^2t^2)}} = \frac{-k d\phi}{\Delta\phi'}$	$t = \frac{\cos \phi}{c},$	$k^2 = \frac{1}{1+c^2}$
V.	$\frac{dt}{\sqrt{(1+t^2)(c^2t^2-1)}} = \frac{k'd\phi}{\Delta\phi'}$	$t = \frac{\sec \phi}{c},$	$k^2 = \frac{c^2}{1+c^2}$
VI.	$\frac{dt}{\sqrt{(1-t^2)(1-c^2t^2)}} = \frac{d\phi}{\Delta\phi'}$	$t = \sin \phi,$	$k^2 = c^2$
VIa.	$\frac{dt}{\sqrt{(t^2-1)(c^2t^2-1)}} = -\frac{d\phi}{\Delta\phi'}$	$t = \frac{1}{c \sin \phi},$	$k^2 = c^2$
VII.	$\frac{dt}{\sqrt{(t^2-1)(1-c^2t^2)}} = -\frac{d\phi}{\Delta\phi'}$	$t^2 = \sin^2 \phi + \frac{\cos^2 \phi}{c^2},$	$k^2 = 1 - c^2$

The formulas VI and VIa have the same form; in VI it is necessary that $t \leq 1$, while in VIa it is required that $t \geq \frac{1}{c}$.

Art. 4. It is seen that the eight transformations in the table are all of the form

$$t^2 = \frac{A + B \sin^2 \phi}{C + D \sin^2 \phi}, \quad \dots \dots \dots (i)$$

where $A, B, C,$ and D are real constants; at the same time it is seen that by means of real substitutions the following reduction can always be made:

$$\frac{dx}{\sqrt{R(x)}} = \pm \frac{1}{M} \frac{d\phi}{\Delta\phi} = \pm \frac{1}{M} \frac{dv}{\sqrt{(1-v^2)(1-k^2v^2)}},$$

where $v = \sin \phi$.

These substitutions and reductions are given in full in Chap. III.

The radical in $\frac{dv}{\sqrt{(1-v^2)(1-k^2v^2)}}$ is *real* for real values of v that are 1° less than unity and 2° greater than $\frac{1}{k}$. In the latter case, write $v = \frac{1}{ks}$, and then

$$\frac{dv}{\sqrt{(1-v^2)(1-k^2v^2)}} = -\frac{ds}{\sqrt{(1-s^2)(1-k^2s^2)}}.$$

In this substitution as v passes from $\frac{1}{k}$ to ∞ , the variable s passes from 1 to 0.

It is therefore concluded that by making the real substitution (*i*), the differential expression *

$$\frac{dt}{\sqrt{\pm(1 \pm g^2t^2)(1 \pm h^2t^2)}}$$

may be reduced to the form

$$\pm \frac{1}{M} \frac{dv}{\sqrt{(1-v^2)(1-k^2v^2)}},$$

where the variable v lies within the interval 0 . . . 1. Such transformations fail if the expression under the root contains only even powers of t , the two roots in t^2 being imaginary, i.e., if $R(x) = Ax^4 + 2Bx^2 + C$, where $B^2 - AC < 0$. This case is considered in Art. 34.

Art. 5. It is also seen that the general elliptic integral

$$\int \frac{Q(t)}{\sqrt{R(t)}} dt,$$

* For other transformations and tables, see Tannery et Molk, *Fonctions Elliptiques*, Vol. IV, p. 34; Cayley, *Elliptic Functions*, pp. 315-16; Appell et Lacour, *Fonctions Elliptiques*, pp. 240-243.

where $Q(t)$ is any rational function of t , and $R(t)$ is of the fourth degree in t , may by the real substitutions

$$t = \frac{p+q\tau}{1+\tau}, \quad \tau = \frac{a+bx^2}{c+dx^2},$$

be transformed into

$$\int \frac{f(x)dx}{\sqrt{(1-x^2)(1-k^2x^2)}},$$

where $f(x)$ is a rational function of x . The evaluation of this latter integral, see my *Elliptic Functions*, I, p. 186, may be made to depend upon that of three types of integral, viz.:

$$F(k, x) = \int \frac{dx}{\sqrt{(1-x^2)(1-k^2x^2)}},$$

$$E(k, x) = \int \frac{\sqrt{1-k^2x^2}}{\sqrt{1-x^2}} dx,$$

$$\Pi(n, k, x) = \int \frac{dx}{(1+nx^2)\sqrt{(1-x^2)(1-k^2x^2)}}.$$

Writing $x = \sin \phi$, and putting $\sqrt{1-k^2 \sin^2 \phi} = \Delta(k, \phi)$, there results the *Legendre notation as normal integrals of the first kind*

$$F(k, \phi) = \int_0^\phi \frac{d\phi}{\Delta(k, \phi)},$$

of the *second kind*,

$$E(k, \phi) = \int_0^\phi \Delta(k, \phi) d\phi,$$

and of the *third kind*,

$$\Pi(n, k, \phi) = \int_0^\phi \frac{d\phi}{(1+n \sin^2 \phi)\Delta(k, \phi)}.$$

The modulus k is omitted from the notation when no particular emphasis is put upon it.

The evaluation of these integrals is reserved for Chap. IV. However, the nature of the first two integrals may be studied by observing the graphs in the next article.

Art. 6. *Graphs of the integrals $F(k, \phi)$ and $E(k, \phi)$.* In

Fig. 1 there are traced the curves $y = \frac{1}{\Delta(k, \phi)}$ and $y = \Delta(k, \phi)$.

Let values of ϕ be laid off upon the X -axis. It is seen that the areas of these curves included between the x -axis and the ordinates corresponding to the abscissa ϕ will represent the integrals $F(k, \phi)$ and $E(k, \phi)$. See Cayley, *Elliptic Functions*, p. 41.

If $k=0$, then $\Delta\phi=1$, and the curves $y=\Delta\phi$, $y=\frac{1}{\Delta\phi}$ each become the straight line $y=1$; while the corresponding integrals

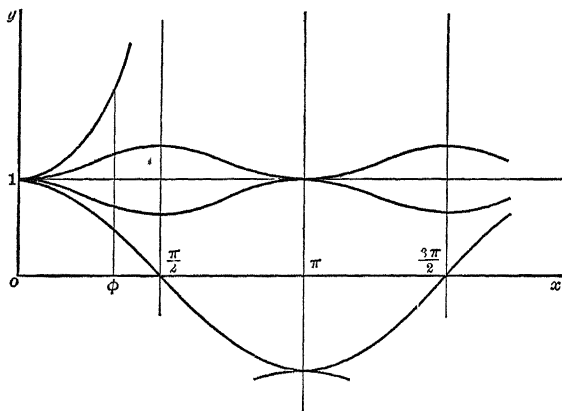

FIG 1.

$F(\phi)$, $E(\phi)$ are both equal to ϕ and are represented by rectangles upon the sides ϕ and 1. When $0 < k < 1$, the curve $y = \frac{1}{\Delta\phi}$ lies entirely above the line $y=1$, while $y = \Delta\phi$ lies below it. As ϕ increases from zero, the integrals $F(\phi)$ and $E(\phi)$ increase from zero in a continuous manner, the integral $F(\phi)$ being always the larger. Further, for a given value of ϕ , as k increases the integral $F(\phi)$ increases and $E(\phi)$ diminishes; and conversely as k decreases, $F(\phi)$ diminishes and $E(\phi)$ increases.

If $F\left(k, \frac{\pi}{2}\right)$ be denoted by $F_1(k)$, or F_1 , and if we put

$E_1 = E\left(k, \frac{\pi}{2}\right)$, it is seen that when $k=0$, $F\left(0, \frac{\pi}{2}\right) = F_1(0) = \frac{\pi}{2} = E_1(0)$. When k has a fixed value, it is often omitted in the notation. F_1 and E_1 are called *complete* integrals.

It is evident that both curves are symmetric about the line $\phi = \frac{1}{2}\pi$ and that for a fixed value of k , it is sufficient to

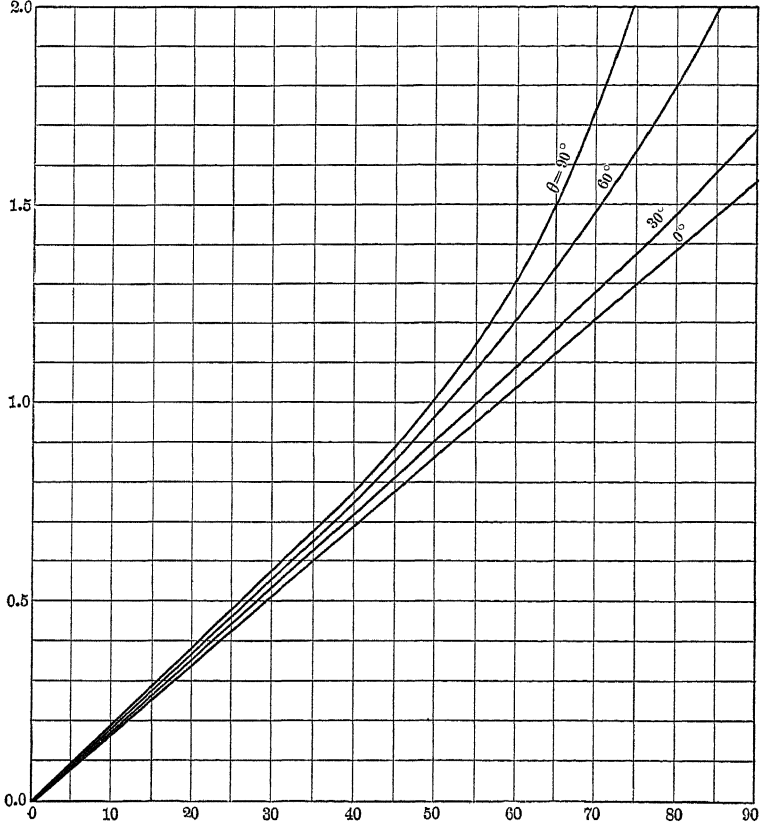

FIG. 2. The Elliptic Integral $F(\theta, \phi)$. $k = \sin \theta$. $\longrightarrow \phi$

know the values of ϕ from 0 to $\frac{1}{2}\pi$. For $F(\pi) = 2F_1$, and for any value $\phi = \alpha$, $F(\alpha) = F(\pi) - F(\pi - \alpha)$, or $F(\pi - \alpha) = 2F_1 - F(\alpha)$. In the latter formula, as α diminishes from $\frac{\pi}{2}$ to 0, $F(\phi)$ increases from $\frac{\pi}{2}$ to π .

Further noting that $F(-\alpha) = -F(\alpha)$, the formula

$$\begin{aligned} F(\alpha) &= F(\pi) + F(\alpha - \pi), \\ &= 2F_1 + F(\alpha - \pi), \end{aligned}$$

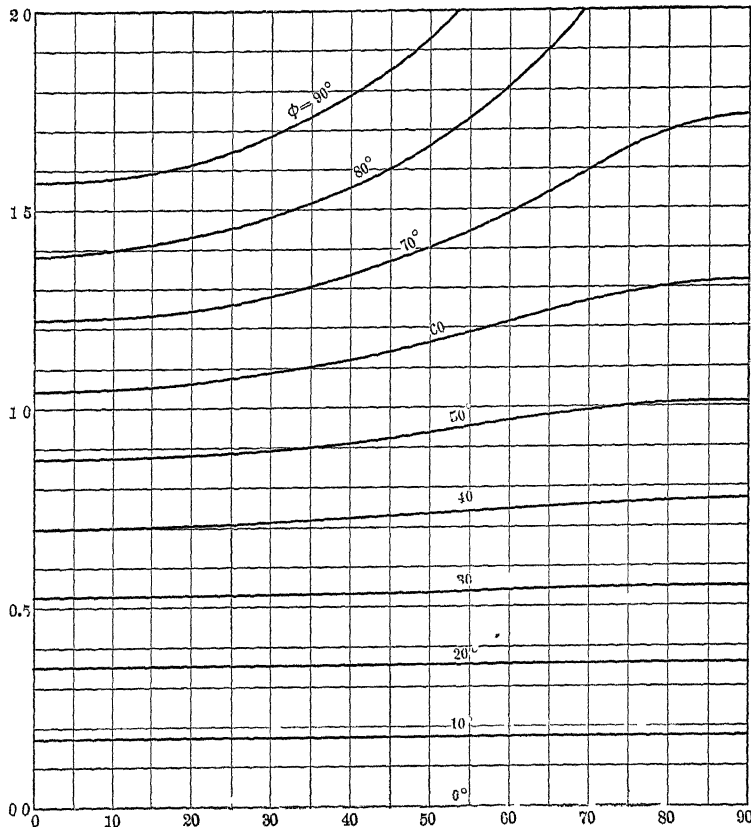

FIG 3 The Elliptic Integral $F(\theta, \phi)$ $k = \sin \theta$ $\longrightarrow \theta$

gives the values of $F(\phi)$ for values $\phi = \pi$ to $\phi = 2\pi$, etc. In general,

$$\begin{aligned} F(m\pi \pm \alpha) &= 2mF_1 \pm F(\alpha), \\ E(m\pi \pm \alpha) &= 2mE_1 \pm E(\alpha). \end{aligned}$$

Art. 7. When $k = 1$, the graphs of the two curves in Fig. 1 are entirely changed, the curve $y = \Delta\phi$ becoming $y = \cos \phi$, which as before lies wholly below the line $y = 1$. The curve $y = \frac{1}{\Delta\phi}$

becomes $y = \sec \phi$. The ordinate for this latter curve becomes infinite for $\phi = \frac{1}{2}\pi$, and between the values $\frac{1}{2}\pi$ and $\frac{3}{2}\pi$ there is a branch lying wholly below the line $y = -1$, the ordinates for the values $\phi = \frac{1}{2}\pi$ and $\phi = \frac{3}{2}\pi$ being $= -\infty$.

For the values $\frac{3}{2}\pi$ and $\frac{5}{2}\pi$ there is a branch lying wholly

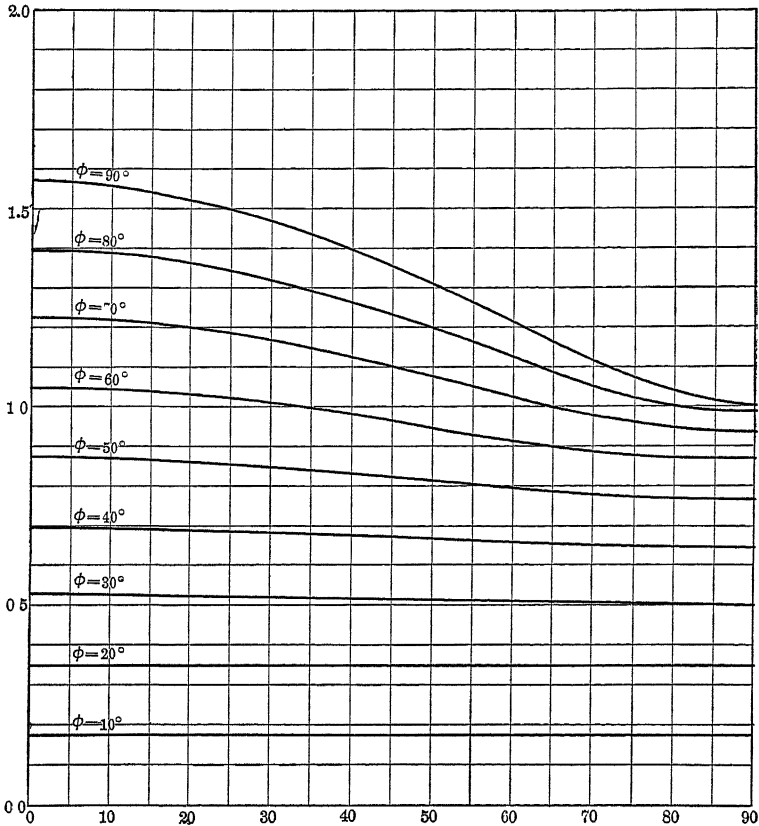

FIG 4 The Elliptic Integral $E(\theta, \phi)$. $k = \sin \theta$. $\longrightarrow \theta$

above the line $y = +1$, the ordinates for $\frac{3}{2}\pi$ and $\frac{5}{2}\pi$ being $+\infty$ and so on

Corresponding to the first curve, $E(\phi) = \int_0^\phi \cos \phi \, d\phi = \sin \phi$ and consequently $E_1 = 1$. This, taken in connection with what was given above, shows that as k increases from 0 to 1, E_1 decreases from $\frac{1}{2}\pi$ to 1

For the second curve, $F(\phi) = \int_0^\phi \sec \phi \, d\phi = \log \tan \left(\frac{\pi}{4} + \frac{\phi}{2} \right)$, so that F_1 is logarithmically infinite when $k = 1$; and this taken in connection with what was given above, shows that

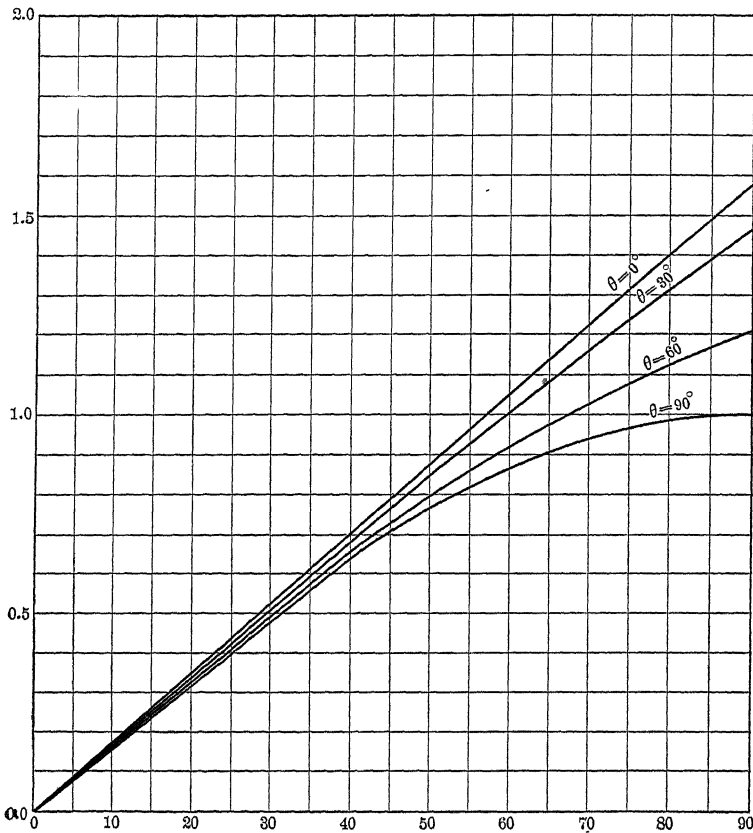

FIG. 5. The Elliptic Integral $E(\theta, \phi)$. $k = \sin \theta$.

as k increases from 0 to 1, F_1 increases from $\frac{1}{2}\pi$ to logarithmic infinity.

Art. 8. In Figs. 2-5 are added other graphs of the integrals $F(k, \phi)$ and $E(k, \phi)$ which require no further explanation. At the end of the book are found tables which give the values of these integrals for fixed values of k and ϕ .

EXAMPLES

1. A quartic function with real coefficients is always equal to the product of two factors $M=l+2mx+nx^2$, $N=\lambda+2\mu x+\nu x^2$, where all the coefficients are real. Remove the coefficient of x in M and N in the integral

$$\int \frac{dx}{\sqrt{MN}}$$

and thereby reduce this integral to

$$\int \frac{(q-p)dy}{\sqrt{(ay^2+b)(a'y^2+b')}} .$$

by a substitution $x = \frac{p+qy}{1+y}$, and show that p and q are real. *Legendre*, Vol. I., Chap. II.

2. Show that
$$\int \frac{f(x)dx}{\sqrt{S(x)}}$$

may be reduced to the integral

$$\int \frac{g(z)dz}{\sqrt{4z^3-g_2z-g_3}}$$

where f and g are rational functions of their arguments and

$$S(x) = ax^3 + 3bx^2 + 3cx + d.$$

The substitution required is $x = mz + n$, where $n = -\frac{b}{a}$, $am^3 = 4$.

Appell et Lacour, p. 247.

3. Knowing a real root α of $R(x)$, find the form of $\frac{dx}{\sqrt{R(x)}}$, when $x = \alpha + \frac{1}{y}$.

Write $R(x) = (x-\alpha)(cx^3 + c_1x^2 + c_2x + c_3)$. *Levy*, p. 77.

4. Show that the substitution

$$\sqrt{cx} = \frac{(1 + \sin \phi) + \sqrt{c}(1 - \sin \phi)}{(1 - \sin \phi) + \sqrt{c}(1 + \sin \phi)}$$

transforms

$$\frac{dx}{\sqrt{(x^2-1)(1-c^2x^2)}} \text{ into } \frac{(1+\sqrt{k})^2 d\phi}{2\sqrt{1-k^2 \sin^2 \phi}}$$

where

$$k = \left(\frac{1 - \sqrt{c}}{1 + \sqrt{c}} \right)^2.$$

5. Show that by the substitution $x = \frac{1-y}{1+y} \sqrt{\frac{\lambda}{\mu}}$, the integral in which $R(x)$ has the form $\lambda^2 + 2\lambda\mu \cos\theta x^2 + \mu^2 x^4$, is transformed into one which has under the radical an expression of the form $m^2(1+g^2y^2)(1+k^2y^2)$.

Legendre, Vol. I, Chap. XI.

6. If the four roots of X are all real, such that $a > \beta > \gamma > \delta$, show that the substitution

$$x = \frac{\gamma(\beta - \delta) - \delta(\beta - \gamma) \sin^2 \phi}{(\beta - \delta) - (\beta - \gamma) \sin^2 \phi}$$

transforms

$$\frac{dx}{\sqrt{X}} \text{ into } \frac{2}{\sqrt{(\alpha - \gamma)(\beta - \delta)}} \frac{d\phi}{\sqrt{1 - k^2 \sin^2 \phi}},$$

where

$$k^2 = \frac{\beta - \gamma}{\alpha - \gamma} \frac{\alpha - \delta}{\beta - \delta} \text{ and } \gamma < x < \beta.$$

7. If Y is of the third degree and if its roots α, β, γ are all real, such that $a > \beta > \gamma$, show that the substitution $y = \gamma + (\beta - \gamma) \sin^2 \phi$ transforms

$$\frac{dy}{\sqrt{Y}} \text{ into } \frac{2}{\sqrt{\alpha - \gamma}} \frac{d\phi}{\sqrt{1 - k^2 \sin^2 \phi}},$$

where

$$k^2 = \frac{\beta - \gamma}{\alpha - \gamma} \text{ and } \gamma < y < \beta.$$

8. If X is of the fourth degree with roots α, β , real and $\gamma, \delta = \rho \pm i\sigma$, and if $M^2 = (\rho - \alpha)^2 + \sigma^2$, $N^2 = (\rho - \beta)^2 + \sigma^2$, show that the substitution

$$\frac{x - \alpha}{x - \beta} = \frac{M}{N} \frac{1 - \cos \phi}{1 + \cos \phi}$$

transforms

$$\frac{dx}{\sqrt{(x - \alpha)(x - \beta)[(x - \rho)^2 + \sigma^2]}} \text{ into } \frac{1}{\sqrt{MN}} \frac{d\phi}{\sqrt{1 - k^2 \sin^2 \phi}},$$

where

$$k^2 = \frac{1}{2} \frac{(M + N)^2 - (\alpha - \beta)^2}{2MN}$$

and

$$\infty > x > \alpha \text{ or } \beta > x > -\infty.$$

9. Show that the substitution

$$t = e_1 + \frac{(e_2 - e_1)(e_3 - e_1)}{s - e_1}$$

transforms the integral

$$\int \frac{dt}{\sqrt{(t - e_1)(t - e_2)(t - e_3)}}$$

into itself.

10. Show that the substitutions

$$t = \frac{z - a_1}{z - a_2} : \frac{a_2 - a_4}{a_2 - a_1}, \quad k^2 = \frac{a_3 - a_4}{a_3 - a_1} : \frac{a_2 - a_1}{a_2 - a_4};$$

transform

$$\int_0^t \frac{dt}{\sqrt{i(1-t)(1-k^2t)}} \text{ into } \pm \sqrt{(a_4 - a_2)(a_1 - a_3)} \int_{a_1}^z \frac{dz}{\sqrt{(z - a_1)(z - a_2)(z - a_3)(z - a_4)}}.$$

11. Prove that the substitution

$$\frac{z - a_1}{z - a_2} : \frac{a_3 - a_1}{a_3 - a_2} = \frac{t - a_2}{t - a_1} : \frac{a_4 - a_2}{a_4 - a_1}$$

transforms

$$\int \frac{dz}{\sqrt{A(z - a_1)(z - a_2)(z - a_3)(z - a_4)}} \text{ into } \int \frac{dt}{\sqrt{A(t - a_1)(t - a_2)(t - a_3)(t - a_4)}}.$$

CHAPTER II

THE ELLIPTIC FUNCTIONS

Art. 9. The expressions $F(k, \phi)$, $E(k, \phi)$, $\Pi(n, k, \phi)$ were called by Legendre *elliptic functions*; these quantities are, however, *elliptic integrals*. It was Abel* who, about 1823, pointed out that if one studied the integral u as a function of x in

$$u = \int_0^x \frac{dx}{\sqrt{(1-x^2)(1-k^2x^2)}} = \int_0^\phi \frac{d\phi}{\sqrt{1-k^2 \sin^2 \phi}}, \quad x = \sin \phi, \quad (1)$$

the same difficulty was met, as if he were to study the trigonometric and logarithmic functions by considering u as a function of x in

$$u = \int \frac{dx}{\sqrt{1-x^2}} = \sin^{-1} x, \quad \text{or} \quad u = \int_1^x \frac{dx}{x} = \log x.$$

Abel proposed instead to study the upper limit x as a function of u . Jacobi (*Fundamenta Nova*, § 17) introduced the notation $\phi = \text{amplitude}$ of u , and written $\phi = \text{am } u$. Considered as a function of u , we have $x = \sin \phi = \sin \text{am } u$, and associated with this function are the two other elliptic functions $\cos \phi = \cos \text{am } u$ and $\Delta \phi = \Delta \text{am } u = \sqrt{1-k^2 \sin^2 \phi}$. Gudermann (teacher of Weierstrass) in *Crelle's Journal*, Bd. 18, p. 12, proposed to abbreviate this notation and to write

$$\begin{aligned} x &= \sin \phi = \text{sn } u, \\ \sqrt{1-x^2} &= \cos \phi = \text{cn } u, \\ \sqrt{1-k^2x^2} &= \Delta \phi = \text{dn } u, \end{aligned}$$

* Abel (*Œuvres*, Sylow and Lie edition, T. I., p. 263 and p. 518, 1827-30).

It follows at once that

$$\operatorname{sn}^2 u + \operatorname{cn}^2 u = 1,$$

$$d\operatorname{sn}^2 u + k^2 \operatorname{sn}^2 u = 1.$$

From (1) results $\frac{du}{d\phi} = \frac{1}{\Delta\phi}$ or $\frac{d\phi}{du} = \Delta\phi$, so that $\frac{d}{du} \operatorname{am} u = \Delta \operatorname{am} u = dn u$

It is also evident that

$$\frac{d}{du} \operatorname{sn} u = \frac{d}{du} \sin \phi = \cos \phi \frac{d\phi}{du} = \operatorname{cn} u \operatorname{dn} u,$$

$$\frac{d}{du} \operatorname{cn} u = -\operatorname{sn} u \operatorname{dn} u,$$

$$\frac{d}{du} \operatorname{dn} u = -k^2 \operatorname{sn} u \operatorname{cn} u.$$

Further, if $u = 0$, then the upper limit $\phi = 0$, so that $\operatorname{am} 0 = 0$, and consequently, $\operatorname{sn} 0 = 0$, $\operatorname{cn} 0 = 1$, $\operatorname{dn} 0 = 1$.

If ϕ be changed into $-\phi$, it is seen that u changes its sign, so that $\operatorname{am}(-u) = -\operatorname{am} u$, and

$$\operatorname{sn}(-u) = -\operatorname{sn} u, \quad \operatorname{cn}(-u) = \operatorname{cn} u, \quad \operatorname{dn}(-u) = \operatorname{dn} u.$$

Art. 10. In the theory of circular functions there is found the numerical transcendent π , a quantity such that $\sin \frac{\pi}{2} = 1$,

$\cos \frac{\pi}{2} = 0$. Writing

$$u = \int_0^x \frac{dx}{\sqrt{1-x^2}} = \sin^{-1} x,$$

we have $x = \sin u$. Thus $\frac{\pi}{2}$ may be defined as the complete integral

$$\frac{\pi}{2} = \int_0^1 \frac{dx}{\sqrt{1-x^2}}.$$

Similarly a real positive quantity K (Jacobi) may be defined through

$$K = \int_0^1 \frac{dx}{\sqrt{(1-x^2)(1-k^2x^2)}} = \int_0^{\frac{\pi}{2}} \frac{d\phi}{\sqrt{1-k^2 \sin^2 \phi}} = F\left(k, \frac{\pi}{2}\right) \quad (\text{Art. 6}).$$

Associated with K is the transcendental quantity K' , which is the same function of the complementary modulus k' as K is of k . The transcendental nature of these two functions of k and k' may be observed by considering the following infinite series through which they are expressed.

If $(1 - k^2 \sin^2 \phi)^{-1}$ be expanded in a series, then

$$\begin{aligned} F(k, \phi) &= \int_0^\phi \frac{d\phi}{\sqrt{1-k^2 \sin^2 \phi}} \\ &= \phi + \frac{1}{2}k^2 v_2 + \dots + \frac{1 \cdot 3 \cdot \dots \cdot (2n-1)}{2 \cdot 4 \cdot \dots \cdot 2n} k^{2n} v_{2n} + \dots, \end{aligned}$$

$$\text{where } v_{2n} = \int_0^\phi \sin^{2n} \phi \, d\phi.$$

In particular, if $\phi = \frac{\pi}{2}$, we have by Wallis's Theorem,

$$\int_0^{\frac{\pi}{2}} \sin^{2n} \phi \, d\phi = \frac{1 \cdot 3 \cdot \dots \cdot 2n-1}{2 \cdot 4 \cdot \dots \cdot 2n} \frac{\pi}{2}.$$

It follows that

$$\frac{2}{\pi} K = 1 + \left(\frac{1}{2}\right)^2 k^2 + \left(\frac{1 \cdot 3}{2 \cdot 4}\right)^2 k^4 + \left(\frac{1 \cdot 3 \cdot 5}{2 \cdot 4 \cdot 6}\right)^2 k^6 + \dots$$

Similarly, it may be proved that

$$\frac{2}{\pi} E\left(k, \frac{\pi}{2}\right) = 1 - \left(\frac{1}{2}\right)^2 k^2 - \left(\frac{1 \cdot 3}{2 \cdot 4}\right)^2 \frac{k^4}{3} - \left(\frac{1 \cdot 3 \cdot 5}{2 \cdot 4 \cdot 6}\right)^2 \frac{k^6}{5} - \dots$$

which confirm the results of Arts. 6 and 7.

Art. 11. If in the integral $\int_{\frac{2n-1}{2}\pi}^{n\pi} \frac{d\phi}{\Delta\phi}$ there be put $\phi = n\pi - \theta$,

then it becomes

$$\int_0^{\frac{\pi}{2}} \frac{d\theta}{\Delta\theta} = K; \text{ and if in the integral } \int_{n\pi}^{\frac{2n+1}{2}\pi} \frac{d\phi}{\Delta\phi}$$

we put $\phi = n\pi + \theta$, then this integral is

$$\int_0^{\frac{\pi}{2}} \frac{d\theta}{\Delta\theta} = K.$$

It follows that

$$\int_0^{\frac{\pi}{2}} \frac{d\phi}{\Delta\phi} = \int_0^{\frac{\pi}{2}} \frac{d\phi}{\Delta\phi} + \int_{\frac{\pi}{2}}^{\pi} \frac{d\phi}{\Delta\phi} + \dots + \int_{(n-1)\frac{\pi}{2}}^{n\frac{\pi}{2}} \frac{d\phi}{\Delta\phi} = nK,$$

so that $\frac{n\pi}{2} = am nK$; or, since $\frac{\pi}{2} = am K$, we have $am nK = n am K$.

Note that

$$\int_0^{n\pi+\beta} \frac{d\phi}{\Delta\phi} = \int_0^{n\pi} \frac{d\phi}{\Delta\phi} + \int_{n\pi}^{n\pi+\beta} \frac{d\phi}{\Delta\phi} = 2nK + u,$$

where

$$u = \int_{n\pi}^{n\pi+\beta} \frac{d\phi}{\Delta\phi} = \int_0^{\beta} \frac{d\theta}{\Delta\theta};$$

further, since any arc α may be put $= n\pi \pm \beta$, where β is an arc between 0 and $\frac{\pi}{2}$, we may always write

$$\alpha = n\pi \pm \beta = am(2nK \pm u),$$

or

$$2n am K \pm am u = am(2nK \pm u).$$

Art. 12. Making use of the formula just written, it is seen that $am K = \frac{\pi}{2}$,

$$sn K = 1, \quad cn K = 0, \quad dn K = k'.$$

$$sn(u \pm 2K) = -sn u, \quad cn(u \pm 2K) = -cn u, \quad dn(u \pm 2K) = dn u;$$

$$sn(u \pm 4K) = sn u, \quad cn(u \pm 4K) = cn u, \quad dn(u \pm 4K) = dn u.$$

Note that $4K$ is a *period* of the three elliptic transcendents $sn u$, $cn u$ and $dn u$; in fact, it is seen that $2K$ is a period of

$dn u$ and of $\frac{sn u}{cn u} = tn u$. Also note that

$$\begin{aligned} \operatorname{sn} 2K &= 0, & \operatorname{cn} 2K &= -1, & \operatorname{dn} 2K &= 1, \\ \operatorname{sn} 4K &= 0, & \operatorname{cn} 4K &= 1, & \operatorname{dn} 4K &= 1. \end{aligned}$$

Of course, the modulus of the above functions is k ; and, since K' is the same function of k' as K is of k , we also have

$$\begin{aligned} \operatorname{sn}(u \pm 2K', k') &= -\operatorname{sn}(u, k'), \\ \operatorname{sn}(u \pm 4K', k') &= \operatorname{sn}(u, k'), \text{ etc.} \end{aligned}$$

Art. 13. *The Gudermannian.* As introductory to the Jacobi imaginary transformation of the following article, there is a particular case * where $k = 1$. Then

$$u = F(1, \phi) = \int_0^\phi \frac{d\phi}{\sqrt{1 - \sin^2 \phi}} = \log \tan \left(\frac{\pi}{4} + \frac{\phi}{2} \right). \quad (\text{Cf. Art. 7.})$$

Here ϕ , considered as a function of u , may be called the Gudermannian and written $\phi = \operatorname{gd} u$, the functions corresponding to $\operatorname{sn} u$ and $\operatorname{cn} u$ being $\operatorname{sg} u$ and $\operatorname{cg} u$. Then

$$e^u = \tan \left(\frac{\pi}{4} + \frac{\phi}{2} \right) = \frac{1 + \tan \phi/2}{1 - \tan \phi/2} = \frac{1 + \sin \phi}{\cos \phi} = \frac{\cos \phi}{1 - \sin \phi};$$

or,

$$e^u = \frac{1 + \operatorname{sg} u}{\operatorname{cg} u}, \quad e^{-u} = \frac{\operatorname{cg} u}{1 + \operatorname{sg} u} = \frac{1 - \operatorname{sg} u}{\operatorname{cg} u}.$$

It follows that

$$\operatorname{cg} u = \frac{2}{e^u + e^{-u}} = \frac{1}{\cos iu} = \frac{1}{\cosh u} = \operatorname{sech} u,$$

and

$$\operatorname{sg} u = \frac{e^u - e^{-u}}{e^u + e^{-u}} = -i \frac{\sin iu}{\cos iu} = \frac{\sinh u}{\cosh u} = \tanh u.$$

These formulas may be written

$$\begin{array}{l|l} \operatorname{sg} u = -i \tan iu, & \sin iu = i \operatorname{tg} u, \\ \operatorname{cg} u = 1/\cos iu, & \cos iu = 1/\operatorname{cg} u, \\ \operatorname{tg} u = -i \sin iu; & \tan iu = i \operatorname{sg} u. \end{array}$$

* See Gudermann, *Crelle*, Bd. 18, pp. 1, et seq.; see also Cayley, loc. cit. p. 56; Weierstrass, *Math. Werke* I, pp. 1-49 and the remark p. 50.

The above relations may also be derived by considering two angles θ and ϕ connected by the equation $\cos \theta \cos \phi = 1$. For there follows at once

$$\begin{array}{l|l} \sin \theta = i \tan \phi, & \sin \phi = -i \tan \theta, \\ \cos \theta = 1/\cos \phi, & \cos \phi = 1/\cos \theta, \\ \tan \theta = i \sin \phi, & \tan \phi = -i \sin \theta. \end{array}$$

Further, there results,

$$\cos \theta d\theta = i \sec^2 \phi d\phi, \quad \text{or} \quad d\theta = i \frac{d\phi}{\cos \phi}.$$

It follows that

$$\theta = i \log \tan \left(\frac{\pi}{4} + \frac{\phi}{2} \right).$$

Then, by assuming that $\phi = gd u$, we have $\theta = iu$, and consequently the foregoing relations.

Art. 14. *Jacobi's Imaginary Transformations.** Writing $\sin \theta = i \tan \phi$, $\cos \theta = \frac{1}{\cos \phi}$, $\sin \phi = -i \tan \theta$, $\Delta(\theta, k) = \frac{\Delta(\phi, k')}{\cos \phi}$,

we have $d\theta = i \frac{d\phi}{\cos \phi}$ and $\int_0^\theta \frac{d\theta}{\Delta(\theta, k)} = i \int_0^\phi \frac{d\phi}{\Delta(\phi, k')}$.

If, then, $\int_0^\phi \frac{d\phi}{\Delta(\phi, k')} = u$, so that $\phi = am(u, k')$, there results $\int_0^\theta \frac{d\theta}{\Delta(\theta, k)} = iu$, and $\theta = am iu$.

These expressions, substituted in the above relations, give

$$sn(iu, k) = i \, tn(u, k'),$$

$$cn(iu, k) = \frac{1}{cn(u, k')},$$

$$dn(iu, k) = \frac{dn(u, k')}{cn(u, k')}.$$

From this it is evident that the two functions cn and dn have real values for imaginary values of the argument, while $sn(iu)$ is an imaginary quantity.

* Jacobi, *Fundamenta Nova*, § 19. * See also Abel, *Œuvres*, T. I., p. 272.

Among the trigonometric and exponential functions, we have, for example, the relation

$$\cos iu = \frac{e^u + e^{-u}}{2},$$

where the argument of the trigonometric function is real while that of the exponential function is real. We note that an elliptic function with imaginary argument may be expressed through an elliptic function with real argument, whose modulus is the complement of the original modulus.

Art. 15. From the formulas of the preceding article it follows at once

$$sn[i(u+4K'), k] = i \operatorname{tn}(u+4K', k') = sn(iu, k),$$

and also

$$cn(iu+4iK', k) = cn(iu, k),$$

$$dn(iu+4iK', k) = dn(iu, k).$$

If in these formulas iu be changed into u , we have

$$sn(u \pm 4iK', k) = sn(u, k),$$

$$cn(u \pm 4iK', k) = cn(u, k),$$

$$dn(u \pm 4iK', k) = dn(u, k).$$

It also follows that $sn(u \pm 4iK, k') = sn(u, k')$, etc. If in the formula $sn(iu) = i \operatorname{tn}(u, k')$, we put $u+2K'$ in the place of u , then

$$sn(iu+2iK', k) = i \operatorname{tn}(u+2K', k') = i \operatorname{tn}(u, k') = sn iu.$$

Changing iu to u , we have

$$sn(u \pm 2iK') = sn u, \quad cn(u \pm 2iK') = -cn u, \quad dn(u \pm 2iK') = -dn u,$$

and

$$sn(2iK') = 0, \quad cn(2iK') = -1, \quad dn(2iK') = -1.$$

The modulus k is always understood, unless another modulus is indicated.

It follows at once that

$$sn(u \pm 4iK') = sn u, \quad cn(u \pm 4iK') = cn u, \quad dn(u \pm 4iK') = dn u$$

and

$$sn(4iK') = 0, \quad cn(4iK') = 1, \quad dn(4iK') = 1.$$

It is also seen that

$$sn(u \pm 2K \pm 2iK') = -sn u, \\ sn(u \pm 4K \pm 4iK') = sn u, \text{ etc.}$$

In particular, notice that

$$\begin{aligned} \text{the periods of } snu &\text{ are } 4K \text{ and } 2iK', \\ \text{the periods of } cnu &\text{ are } 4K \text{ and } 2K + 2iK', \\ \text{the periods of } dnu &\text{ are } 2K \text{ and } 4iK'. \end{aligned}$$

Art. 16. Periodic Functions. Consider the simple case of the exponential function e^u and suppose that $u = x + iy$. It may be shown that $e^{u+2\pi i} = e^u$ for all values of u ; for it is seen that $e^u = e^{x+iy} = e^x(\cos y + i \sin y)$. If we increase u by $2\pi i$, then y is increased by 2π and consequently

$$e^{u+2\pi i} = e^x[\cos(y+2\pi) + i \sin(y+2\pi)] = e^x(\cos y + i \sin y) = e^u.$$

It follows that if it is desired to examine the function e^u , then clearly this function need not be studied in the whole u -plane, but only within a strip which lies above the X -axis and has the breadth 2π ; for we see at once that to every point u_0 which lies without this *period-strip* there corresponds a point u_1 within the strip and in such a way that the function has the same value and the same properties at u_0 and u_1 .

Similarly it is seen that the two functions $\sin u$ and $\cos u$ have the real period 2π , and consequently it is necessary to study these functions only within a period-strip which lies adjacent to the Y -axis with a breadth 2π . As already noted, Abel and Jacobi found that the elliptic functions had two periods. In the preceding article it was seen that $sn u$ had the real period $4K$ and the imaginary period $2iK'$.

On the X -axis lay off a distance $4K$ and on the Y -axis a distance $2K'$ and construct the rectangle on these two sides. Further suppose that the whole plane is filled out with such rectangles.

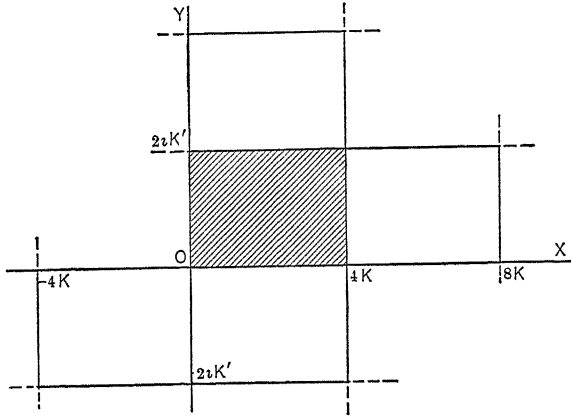

FIG. 6.

Then it will be seen that the function $sn u$ behaves in every rectangle precisely as it does in the initial rectangle. Similar parallelograms may be constructed for the functions $cn u$ and $dn u$. See Art. 21.

Art. 17. Next write $\sin \phi = \frac{\cos \theta}{\Delta \theta}$, so that $\cos \phi = \frac{k' \sin \theta}{\Delta \theta}$, and $\Delta \phi = \frac{k'}{\Delta \theta}$. It follows that $\frac{d\phi}{\Delta \phi} = -\frac{d\theta}{\Delta \theta}$ and consequently

$$\int_0^\phi \frac{d\phi}{\Delta \phi} = \int_\theta^{\frac{\pi}{2}} \frac{d\theta}{\Delta \theta} = \int_0^{\frac{\pi}{2}} \frac{d\theta}{\Delta \theta} - \int_0^\theta \frac{d\theta}{\Delta \theta} = K - u,$$

if we put $u = \int_0^\theta \frac{d\theta}{\Delta \theta}$, or $\theta = am u$. It follows that $\phi = am(K - u)$, and from the above formulas

$$sn(K - u) = \frac{cn u}{dn u}, \quad cn(K - u) = \frac{k' sn u}{dn u}, \quad dn(K - u) = \frac{k'}{dn u}.$$

In these formulas change $-u$ to u and note that $sn(-u) = -sn u$, etc.

It is seen that

$$\begin{aligned} sn(u \pm K) &= \pm \frac{cn u}{dn u} & sn K &= 1, \\ cn(u \pm K) &= \mp \frac{k' sn u}{dn u}, & cn K &= 0, \\ dn(u \pm K) &= + \frac{k'}{dn u}, & dn K &= k'. \end{aligned}$$

For the calculation of the elliptic functions, the above relations permit the reduction of the argument so that it is always comprised between 0 and $\frac{1}{2}K$, just as in trigonometry the angle may be reduced so as to lie between 0 and 45° for the calculation of the circular functions.

Art. 18. In the above formulas put iu in the place of u , and it is seen that

$$\begin{aligned} sn(iu \pm K) &= \pm \frac{cn iu}{dn iu} = \pm \frac{1}{dn(u, k')}, \\ cn(iu \pm K) &= \mp \frac{ik' sn(u, k')}{dn(u, k')}, \\ dn(iu \pm K) &= \frac{k' cn(u, k')}{dn(u, k')}. \end{aligned}$$

Further, in the formulas $sn iu = i \operatorname{tn}(u, k')$, etc., write $u \pm iK$ for u and it is seen that

$$\begin{aligned} sn(iu \pm iK', k) &= i \operatorname{tg} am(u \pm K', k') = -\frac{i}{k} \frac{cn(u, k')}{sn(u, k')}, \\ cn(iu \pm iK', k) &= \mp \frac{dn(u, k')}{sn(u, k')}, \\ dn(iu \pm iK', k) &= \mp \frac{1}{sn(u, k')}. \end{aligned}$$

In the above formulas change iu to u . We then have

$$\begin{aligned} sn(u \pm iK') &= \frac{1}{k} \frac{1}{sn u}, \\ cn(u \pm iK') &= \mp \frac{i}{k} \frac{dn u}{sn u}, \\ dn(u \pm iK') &= \mp i \operatorname{cot} am u. \end{aligned}$$

If in these formulas $u = 0$, then

$$\operatorname{sn}(\pm iK') = \infty, \quad \operatorname{cn}(\pm iK') = \infty, \quad \operatorname{dn}(\pm iK') = \infty.$$

Further, if in the preceding formulas $u + K$ be put in the place of u , then

$$\operatorname{sn}(u + K \pm iK') = \frac{1}{k} \frac{1}{\operatorname{sn}(u + K)} = \frac{1}{k} \frac{\operatorname{dn} u}{\operatorname{cn} u}$$

$$\operatorname{cn}(u + K \pm iK') = \mp \frac{ik'}{k \operatorname{cn} u},$$

$$\operatorname{dn}(u + K \pm iK') = \pm ik' \operatorname{tg} am u;$$

and from these formulas, writing, $u = 0$, there results

$$\operatorname{sn}(K \pm iK') = \frac{1}{k}, \quad \operatorname{cn}(K \pm iK') = \mp \frac{ik'}{k}, \quad \operatorname{dn}(K \pm iK') = 0.$$

Art. 19. Note the analogy of the transcendent K of the elliptic functions to $\frac{\pi}{2}$ of the circular functions. Due to the relation $\operatorname{am}(K - u) = \frac{\pi}{2} - \operatorname{am} u$ (Art. 11) Jacobi called the amplitude of $K - u$ the *co-amplitude* of u and wrote $\operatorname{am}(K - u) = \operatorname{coam} u$.

It follows at once from the above formulas that

$$\sin \operatorname{coam} u = \frac{\operatorname{cn} u}{\operatorname{dn} u},$$

$$\cos \operatorname{coam} u = \frac{k' \operatorname{sn} u}{\operatorname{dn} u},$$

$$\Delta \operatorname{coam} u = \frac{k'}{\operatorname{dn} u}.$$

$$\sin \operatorname{coam}(iu, k) = \frac{1}{\operatorname{dn}(u, k')}, \text{ etc.}$$

Art. 20. Remark. The results obtained for the imaginary argument have been derived by making use of Jacobi's imaginary transformation; and by changing iu into u we have implicitly made the assumption (proved in my *Elliptic Functions*, Vol. I,

Chaps X and XI) that the elliptic functions have the same properties for real and imaginary arguments.

Art. 21. By a *zero* of a function, $sn u$ for example, we mean that value of u which, when substituted for u in $sn u$, causes this function to be zero, while an *infinity* of a function is a value of u which causes the function to become infinite.

In studying the following graphs note that on the boundaries of the period parallelogram of $sn u$, there are six points at which this function becomes zero; but if the adjacent period parallelograms be constructed, it will be seen that only *two* zeros belong to each parallelogram. In fact, in each period-parallelogram there are *two* values of u which cause the function to take any fixed value; that is, any value being fixed, there are always two values of u which cause the function to take this value. From the following graphs it is seen that any *real* value situated within the interval $-\infty$ to $+\infty$ is taken twice by each of the three functions $sn u$, $cn u$, $dn u$.

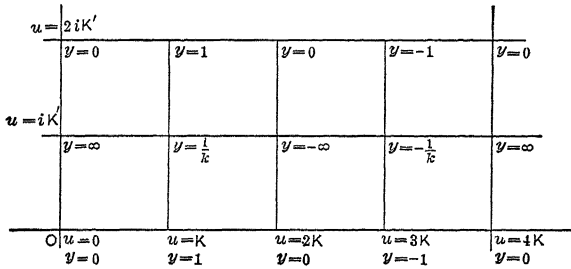

FIG. 7. $y = sn(u, k)$.

ZEROS

$$2mK + 2niK'$$

INFINITIES

$$2mK + (2n + 1)iK'$$

where m and n are any integers.

PERIODS

$$4K, 2iK'$$

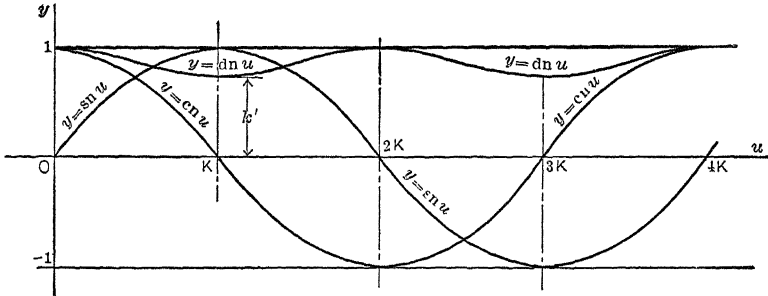

FIG. 8.

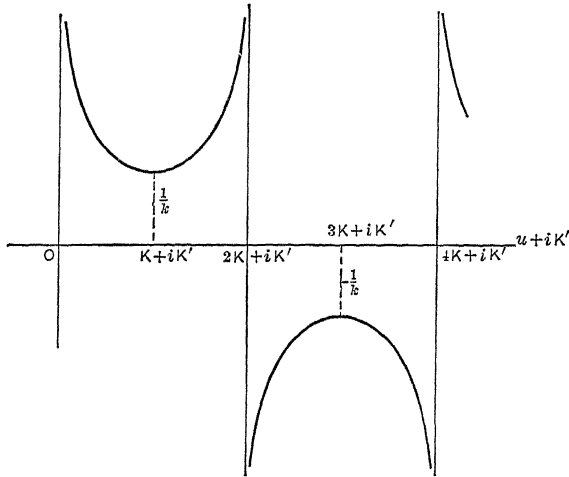

FIG. 9. $y = \text{sn}(u + iK')$.

In Fig. 9, the value iK' coincides with the origin.

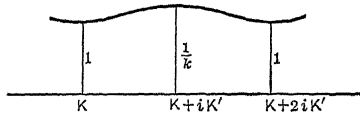

FIG. 10a. $y = \text{sn}(iu + K)$.

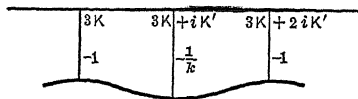

FIG. 10b. $y = \text{sn}(iu + 3K)$.

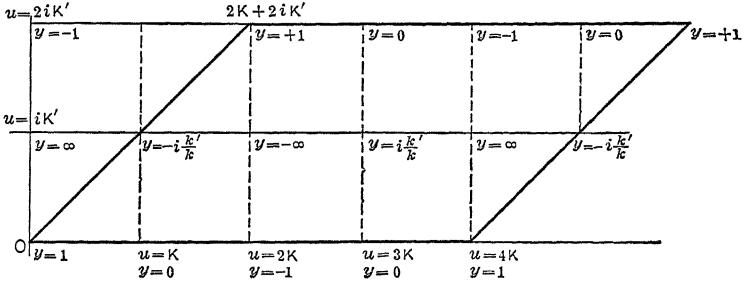

FIG. 11. $y = \text{cn}(u)$.

ZEROS

$$(2m + 1)K + 2niK'$$

INFINITIES

$$2mK + (2n + 1)iK'$$

where m and n are any integers.

PERIODS

$$4K, 2K + 2iK'$$

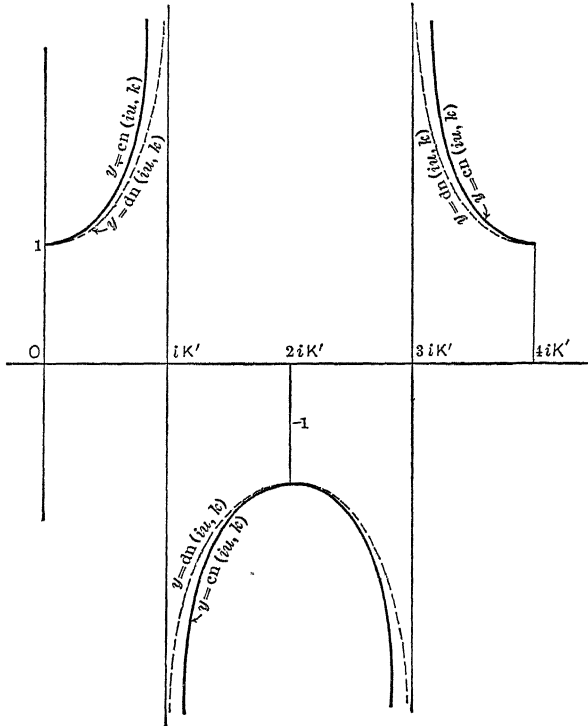

FIG. 12. $y = \text{cn}(iu)$; $y = \text{dn}(iu)$.

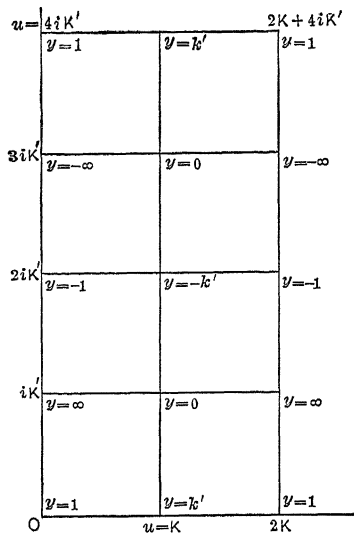

FIG. 13. $y = \text{dn}(u)$.

ZEROS

$$(2m+1)K + (2n+1)iK'$$

where m and n are integers.

INFINITIES

$$2mK + (2n+1)iK'$$

PERIODS

$$2K, 4iK'$$

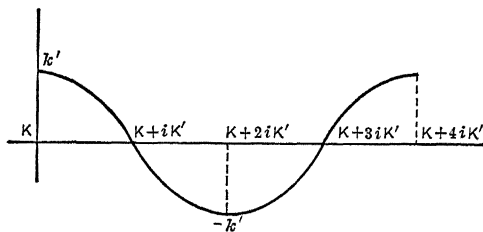

FIG. 14. $y = \text{dn}(K + iu)$.

EXAMPLES

1. In the formulas of Art. 17 put $u = \frac{K}{2}$, and show first that $dn \frac{K}{2} = \sqrt{k'}$ and then $sn^2 \frac{K}{2} = \frac{1-k'}{k^2} = \frac{1}{1+k'}$, $cn^2 \frac{K}{2} = \frac{k'}{1+k'}$, $am \frac{K}{2} = \tan^{-1} \sqrt{\frac{1}{k'}}$.

2. Prove that

$$sn \frac{3}{2}K = \frac{1}{\sqrt{1+k'}}, \quad cn \frac{3}{2}K = -\frac{\sqrt{k'}}{\sqrt{1+k'}}, \quad dn \frac{3}{2}K = \sqrt{k'}$$

3. Prove that

$$sn \frac{iK'}{2} = \frac{1}{\sqrt{k}}, \quad cn \frac{iK'}{2} = \frac{\sqrt{1+k}}{\sqrt{k}}, \quad dn \frac{iK'}{2} = \sqrt{1+k}$$

4. Show that

$$sn(K + \frac{1}{2}iK') = \frac{1}{\sqrt{k}}, \quad cn(K + \frac{1}{2}iK') = -i \frac{\sqrt{1-k}}{\sqrt{k}}, \quad dn(K + \frac{1}{2}iK') = \sqrt{1-k}$$

5. Show that

$$sn(\frac{1}{2}K + \frac{1}{2}iK') = \frac{1}{\sqrt{2k}} [\sqrt{1+k} + i\sqrt{1-k}],$$

$$cn(\frac{3}{2}K + \frac{1}{2}iK') = -\frac{1+i\sqrt{k'}}{\sqrt{2k}},$$

$$dn(\frac{1}{2}K + \frac{3}{2}iK') = -\frac{\sqrt{k'}}{2} (\sqrt{1+k'} + i\sqrt{1-k'}).$$

6. Show that

$$sn(u + K + 3iK') = \frac{dn u}{k cn u},$$

$$cn(u + 3K + iK') = \frac{ik'}{k cn u},$$

$$dn(u + 3K + 3iK') = \frac{-k' sn u}{cn u}.$$

7. Making the linear transformation $x = kz$, we have

$$\int_0^x \frac{dx}{\sqrt{(1-x^2) \left(1 - \frac{x^2}{k^2}\right)}} = k \int_0^z \frac{dz}{\sqrt{(1-z^2) (1-k^2z^2)}}.$$

Further, put

$$u = \int_0^z \frac{dz}{\sqrt{(1-z^2) (1-k^2z^2)}}, \quad ku = \int_0^x \frac{dx}{\sqrt{(1-x^2) \left(1 - \frac{x^2}{k^2}\right)}}$$

and show that

$$\operatorname{sn}\left(ku, \frac{1}{k}\right) = k \operatorname{sn}(u, k),$$

$$\operatorname{cn}\left(ku, \frac{1}{k}\right) = \operatorname{dn}(u, k),$$

$$\operatorname{dn}\left(ku, \frac{1}{k}\right) = \operatorname{cn}(u, k);$$

$$\operatorname{sn}\left(ku, \frac{ik'}{k}\right) = \operatorname{cos coam}(u, k'),$$

$$\operatorname{cn}\left(ku, \frac{ik'}{k}\right) = \operatorname{sin coam}(u, k'),$$

$$\operatorname{dn}\left(ku, \frac{ik'}{k}\right) = \frac{1}{\Delta \operatorname{am}(u, k')}.$$

8. The quadratic substitution $t = \frac{(1+k)z}{1+kz^2}$ transforms $\frac{dz}{\sqrt{(1-z^2)(1-k^2z^2)}}$ into $\frac{Mdt}{\sqrt{(1-t^2)(1-l^2t^2)}}$, where $l = \frac{2\sqrt{k}}{1+k}$ and $M = \frac{1}{1+k}$.

9. Show that

$$\operatorname{sn}\left[(1+k)u, \frac{2\sqrt{k}}{1+k}\right] = \frac{(1+k)\operatorname{sn}(u, k)}{1+k\operatorname{sn}^2(u, k)},$$

$$\operatorname{cn}\left[(1+k)u, \frac{2\sqrt{k}}{1+k}\right] = \frac{\operatorname{cn}(u, k)\operatorname{dn}(u, k)}{1+k\operatorname{sn}^2(u, k)},$$

$$\operatorname{dn}\left[(1+k)u, \frac{2\sqrt{k}}{1+k}\right] = \frac{1-k\operatorname{sn}^2(u, k)}{1+k\operatorname{sn}^2(u, k)}.$$

CHAPTER III

ELLIPTIC INTEGRALS OF THE FIRST KIND REDUCED TO LEGENDRE'S NORMAL FORM

Art. 22. In the elementary calculus such integrals as the following have been studied

$$\int_0^x \frac{dx}{\sqrt{1-x^2}} = \sin^{-1} x = \cos^{-1} \sqrt{1-x^2},$$

$$\int_x^\infty \frac{dx}{x^2+1} = \cot^{-1} x = \tan^{-1} \frac{1}{x},$$

$$\int_1^x \frac{dx}{\sqrt{x^2-1}} = \cosh^{-1} x = \sinh^{-1} \sqrt{x^2-1} = \log \{x + \sqrt{x^2-1}\}.$$

Following Clifford* an analogous notation for the elliptic integrals will be introduced. Write (see Art. 9),

$$x = sn u, \quad \sqrt{1-x^2} = cn u, \quad \sqrt{1-k^2x^2} = dn u.$$

Since (see Art. 9), $\frac{dx}{du} = cn u \, dn u$, it follows that

$$\frac{dx}{du} = \sqrt{(1-x^2)(1-k^2x^2)};$$

or

$$\int_0^x \frac{dx}{\sqrt{(1-x^2)(1-k^2x^2)}} = u = sn^{-1} x = cn^{-1} \sqrt{1-x^2} = dn^{-1} \sqrt{1-k^2x^2} \\ = F(k, \phi) = F(k, \sin^{-1} x). \quad \quad (I)$$

In particular, it is seen from this formula that the substitution $x = \sin \phi$ transforms the integral $\int_0^x \frac{dx}{\sqrt{(1-x^2)(1-k^2x^2)}}$

* Clifford, *Mathematical Papers*, p. 207.

into the normal form $\int_0^\phi \frac{dx}{\sqrt{1-k^2 \sin^2 \phi}} = F(k, \phi)$. Further, from the tables given at the end of the book, which we shall learn later to construct and use, the integral is known as soon as x is fixed.

Similarly, if there be put $x = cn u$, $\sqrt{1-x^2} = sn u$, $\sqrt{k'^2+k^2x^2} = dn u$, $\frac{dx}{dn u} = \frac{d cn u}{du} = -sn u dn u = -\sqrt{(1-x^2)(k'^2+k^2x^2)}$, it follows that

$$\begin{aligned} \int_x^1 \frac{dx}{\sqrt{(1-x^2)(k'^2+k^2x^2)}} &= u = cn^{-1}x = sn^{-1}\sqrt{1-x^2} = dn^{-1}\sqrt{k'^2+k^2x^2} \\ &= F(k, \phi) = F(k, \cos^{-1} x) \\ &= F(k, \sin^{-1}\sqrt{1-x^2}). \quad \dots \quad (2) \end{aligned}$$

It is seen also that the substitution $x = \cos \phi$ transforms the integral on the right-hand side into the normal form.

If $x = dn u$, $\frac{\sqrt{1-x^2}}{k} = sn u$, $\frac{\sqrt{x^2-k'^2}}{k} = cn u$, $\frac{dx}{du} = -k^2 sn u cn u = -\sqrt{(1-x^2)(x^2-k'^2)}$, we have

$$\begin{aligned} \int_x^1 \frac{dx}{\sqrt{(1-x^2)(x^2-k'^2)}} &= u = dn^{-1}x = sn^{-1}\left(\frac{\sqrt{1-x^2}}{k}\right) \\ &= cn^{-1}\left(\frac{\sqrt{x^2-k'^2}}{k}\right) = F(k, \phi) \\ &= F\left[k, \sin^{-1}\left(\frac{\sqrt{1-x^2}}{k}\right)\right]. \quad \dots \quad (3) \end{aligned}$$

Further, writing $x = \tan am u$, it follows that $sn u = \frac{x}{\sqrt{1+x^2}}$,

$$cn u = \frac{1}{\sqrt{1+x^2}}, \quad dn u = \frac{\sqrt{1+k'^2x^2}}{\sqrt{1+x^2}}, \quad \frac{dx}{du} = \frac{dn u}{cn^2u} = \sqrt{(1+x^2)(1+k'^2x^2)},$$

and

$$\begin{aligned} \int_0^x \frac{dx}{\sqrt{(1+x^2)(1+k'^2x^2)}} &= u = tn^{-1}x = sn^{-1}\left(\frac{x}{\sqrt{1+x^2}}\right) \\ &= F(k, \tan^{-1} x). \quad (4) \end{aligned}$$

Art. 23. I. If $a > b > x > 0$, write $x = b \sin \phi$ in the integral,

$$v = \int_0^x \frac{dx}{\sqrt{(a^2 - x^2)(b^2 - x^2)}}$$

and we have, if $k^2 = \frac{b^2}{a^2}$,

$$v = \frac{1}{a} \int_0^\phi \frac{d\phi}{\sqrt{1 - k^2 \sin^2 \phi}} = \frac{1}{a} \operatorname{sn}^{-1} \left[\frac{x}{b}, \frac{b}{a} \right]. \dots (5a)$$

2. If $\infty > x > a$, write $x = \frac{a}{\sin \phi}$, and it is seen that

$$\int_x^\infty \frac{dx}{\sqrt{(x^2 - a^2)(x^2 - b^2)}} = \frac{1}{a} \operatorname{sn}^{-1} \left[\frac{a}{x}, \frac{b}{a} \right]. \dots (5b)$$

If $a > b > x > 0$,

$$\int_x^b \frac{dx}{\sqrt{(a^2 + x^2)(b^2 - x^2)}} = \frac{1}{\sqrt{a^2 + b^2}} \operatorname{cn}^{-1} \left[\frac{x}{b}, \frac{b}{\sqrt{a^2 + b^2}} \right]; (6a)$$

(see IV, in Art. 3), and also

$$\int_b^x \frac{dx}{\sqrt{(a^2 + x^2)(x^2 - b^2)}} = \frac{1}{\sqrt{a^2 + b^2}} \operatorname{cn}^{-1} \left[\frac{b}{x}, \frac{a}{\sqrt{a^2 + b^2}} \right], (6b)$$

(see V in Art. 3).

It is almost superfluous to add that for example in (6a) the substitution $\frac{x}{b} = \cos \phi$ transforms the integral

$$\int_x^b \frac{dx}{\sqrt{(a^2 + x^2)(b^2 - x^2)}}$$

into

$$\frac{1}{\sqrt{a^2 + b^2}} \int_0^\phi \frac{d\phi}{\sqrt{1 - \frac{b^2}{a^2 + b^2} \sin^2 \phi}} = \frac{1}{\sqrt{a^2 + b^2}} F \left[\frac{b}{\sqrt{a^2 + b^2}}, \cos^{-1} \frac{x}{b} \right].$$

It is also seen that if $a > x > b > 0$,

$$\int_x^a \frac{dx}{\sqrt{(a^2 - x^2)(x^2 - b^2)}} = \frac{1}{a} \operatorname{dn}^{-1} \left[\frac{x}{a}, \frac{\sqrt{a^2 - b^2}}{a} \right]; \dots (7)$$

that is, the integral on the left-hand side becomes

$$\frac{1}{a} \int_0^\phi \frac{d\phi}{\sqrt{1 - \frac{a^2 - b^2}{a^2} \sin^2 \phi}},$$

for the substitution

$$\frac{x}{a} = \sqrt{1 - \frac{a^2 - b^2}{a^2} \sin^2 \phi}.$$

Further if $a > b$

$$\int_0^x \frac{dx}{\sqrt{(x^2 + a^2)(x^2 + b^2)}} = \frac{1}{a} \operatorname{tn}^{-1} \left[\frac{x}{b}, \sqrt{\frac{a^2 - b^2}{a^2}} \right] \quad \dots \quad (8)$$

(See I in Art. 3.)

Art. 24. In the formulas (1), (2), (3) and (4) above, substitute x for x^2 , and it is seen that

$$\begin{aligned} \int_0^x \frac{dx}{\sqrt{x(1-x)(1-k^2x)}} &= 2sn^{-1}(\sqrt{x}, k) = 2cn^{-1}(\sqrt{1-x}, k) \\ &= 2dn^{-1}(\sqrt{1-k^2x}, k), \quad \dots \quad (9) \end{aligned}$$

$$\int_x^1 \frac{dx}{\sqrt{x(1-x)(k'^2 + k^2x)}} = 2cn^{-1}(\sqrt{x}, k), \quad \dots \quad (10)$$

$$\int_x^1 \frac{dx}{\sqrt{x(1-x)(x - k'^2)}} = 2dn^{-1}(\sqrt{x}, k), \quad \dots \quad (11)$$

$$\int_0^x \frac{dx}{\sqrt{x(1+x)(1+k'^2x)}} = 2\operatorname{tn}^{-1}(\sqrt{x}, k) \quad \dots \quad (12)$$

Art. 25. Suppose that α, β , and γ are real quantities such that $\alpha > \beta > \gamma$; further write $M = \frac{\sqrt{\alpha - \gamma}}{2}$, $k_1^2 = \frac{\beta - \gamma}{\alpha - \gamma}$ and $k_2^2 = \frac{\alpha - \beta}{\alpha - \gamma}$, where $k_1^2 + k_2^2 = 1$, so that the one is the complementary modulus of the other. Put $X = (x - \alpha)(x - \beta)(x - \gamma)$.

If $\infty > x > \alpha > \beta > \gamma$, write $x - \gamma = (\alpha - \gamma) \operatorname{cosec}^2 \phi$ and we have

$$M \int_x^\infty \frac{dx}{\sqrt{X}} = sn^{-1} \left(\sqrt{\frac{\alpha - \gamma}{x - \gamma}}, k_1 \right) = cn^{-1} \left(\sqrt{\frac{x - \alpha}{x - \gamma}}, k_1 \right). \quad (13)$$

When $\infty > x > \alpha > \beta > \gamma$, it is seen that

$$M \int_{\alpha}^x \frac{dx}{\sqrt{X}} = sn^{-1} \left(\sqrt{\frac{x-\alpha}{x-\beta}}, k_1 \right) = cn^{-1} \left(\sqrt{\frac{\alpha-\beta}{x-\beta}}, k_1 \right), \quad (14)$$

and when $\beta > x > \gamma$, we have

$$\begin{aligned} M \int_x^{\beta} \frac{dx}{\sqrt{X}} &= sn^{-1} \left[\sqrt{\frac{(\alpha-\gamma)(\beta-x)}{(\beta-\gamma)(\alpha-x)}}, k_1 \right] \\ &= cn^{-1} \left[\sqrt{\frac{(\alpha-\beta)(x-\gamma)}{(\beta-\gamma)(\alpha-x)}}, k_1 \right]. \end{aligned} \quad (15)$$

Further if $\beta > x > \gamma$, then

$$\begin{aligned} M \int_{\gamma}^x \frac{dx}{\sqrt{X}} &= sn^{-1} \left(\sqrt{\frac{x-\gamma}{\beta-\gamma}}, k_1 \right) = cn^{-1} \left(\sqrt{\frac{\beta-x}{\beta-\gamma}}, k_1 \right) \\ &= dn^{-1} \left(\sqrt{\frac{\alpha-x}{\alpha-\gamma}}, k_1 \right). \end{aligned} \quad (16)$$

Art. 26. As above write

$$M = \frac{\sqrt{\alpha-\gamma}}{2}, \quad k_2^2 = \frac{\alpha-\beta}{\alpha-\gamma}, \quad X = (x-\alpha)(x-\beta)(x-\gamma).$$

For the interval $\alpha > x > \beta > \gamma$, it is seen that

$$M \int_x^{\alpha} \frac{dx}{\sqrt{-X}} = sn^{-1} \left[\sqrt{\frac{\alpha-x}{\alpha-\beta}}, k_2 \right] = cn^{-1} \left[\sqrt{\frac{x-\beta}{\alpha-\beta}}, k_2 \right], \quad (17)$$

and for the same interval

$$\begin{aligned} M \int_{\beta}^x \frac{dx}{\sqrt{-X}} &= sn^{-1} \left[\sqrt{\frac{(\alpha-\gamma)(x-\beta)}{(\alpha-\beta)(x-\gamma)}}, k_2 \right] \\ &= cn^{-1} \left[\sqrt{\frac{(\beta-\gamma)(\alpha-x)}{(\alpha-\beta)(x-\gamma)}}, k_2 \right]. \end{aligned} \quad (18)$$

Further, if $\gamma > x > -\infty$, then

$$M \int_x^{\gamma} \frac{dx}{\sqrt{-X}} = sn^{-1} \left[\sqrt{\frac{\gamma-x}{\beta-x}}, k_2 \right] = cn^{-1} \left[\sqrt{\frac{\beta-\gamma}{\beta-x}}, k_2 \right], \quad (19)$$

and for the same interval

$$M \int_{-\infty}^x \frac{dx}{\sqrt{-X}} = sn^{-1} \left(\sqrt{\frac{\alpha-\gamma}{\alpha-x}}, k_2 \right) = cn^{-1} \left(\sqrt{\frac{\gamma-x}{\alpha-x}}, k_2 \right). \quad (20)$$

Art. 27. From formula (14) it is seen that, if $\infty > x > \frac{1}{k^2}$,

$$\begin{aligned} \int_{\frac{1}{k^2}}^x \frac{dx}{\sqrt{x(x-1)(k^2x-1)}} &= \frac{1}{k} \int_{\frac{1}{k^2}}^x \frac{c'x}{\sqrt{x(x-1)(x-1/k^2)}} \\ &= 2sn^{-1} \left(\sqrt{\frac{x-1/k^2}{x-1}}, k \right) = 2cn^{-1} \left(\sqrt{\frac{1-k^2}{k^2(x-1)}}, k \right), \quad (21) \end{aligned}$$

and from formula (13) for the same interval,

$$\int_x^{\infty} \frac{dx}{\sqrt{x(1-x)(1-k^2x)}} = 2sn^{-1} \left(\sqrt{\frac{1}{k^2x}}, k \right) = 2cn^{-1} \left(\sqrt{\frac{k^2x-1}{k^2x}}, k \right) \quad (22).$$

Using formula (17), it follows that, if $\frac{1}{k^2} > x > 1$,

$$\begin{aligned} \int_x^{\frac{1}{k^2}} \frac{dx}{\sqrt{x(1-x)(1-k^2x)}} &= 2i sn^{-1} \left(\sqrt{\frac{1-k^2x}{1-k^2}}, k' \right) \\ &= 2i cn^{-1} \left(\sqrt{\frac{k^2(x-1)}{1-k^2}}, k' \right), \quad (23) \end{aligned}$$

and for the same interval (see formula (18)),

$$\begin{aligned} \int_1^x \frac{dx}{\sqrt{x(1-x)(1-k^2x)}} &= 2i sn^{-1} \left(\sqrt{\frac{x-1}{x(1-k^2)}}, k' \right) \\ &= 2i cn^{-1} \left(\sqrt{\frac{1-k^2x}{x(1-k^2)}}, k' \right). \quad (24) \end{aligned}$$

If $0 > x > -\infty$, the formula (19) offers

$$\begin{aligned} \int_x^0 \frac{dx}{\sqrt{x(1-x)(1-k^2x)}} &= 2i sn^{-1} \left(\sqrt{\frac{-x}{1-x}}, k' \right) \\ &= 2i cn^{-1} \left(\sqrt{\frac{1}{1-x}}, k' \right); \quad (25) \end{aligned}$$

while for the same interval it follows from formula (20) that

$$\begin{aligned} \int_{-\infty}^x \frac{dx}{\sqrt{x(1-x)(1-k^2x)}} &= 2i sn^{-1} \left(\sqrt{\frac{1}{1-k^2x}}, k' \right) \\ &= 2i cn^{-1} \left(\sqrt{\frac{-k^2x}{1-k^2x}}, k' \right). \quad (26) \end{aligned}$$

Art. 28. Next let $X = (x - \alpha)(x - \beta)(x - \gamma)(x - \delta)$ and further put

$$N = \frac{\sqrt{(\alpha - \gamma)(\beta - \delta)}}{2}, \quad k_3^2 = \frac{(\beta - \gamma)(\alpha - \delta)}{(\alpha - \gamma)(\beta - \delta)}, \quad k_4^2 = \frac{(\alpha - \beta)(\gamma - \delta)}{(\alpha - \gamma)(\beta - \delta)},$$

and note that $k_3^2 + k_4^2 = 1$.

If then $\infty > x > \alpha$, there results, supposing always that $\alpha > \beta > \gamma > \delta$,

$$\begin{aligned} N \int_{\alpha}^x \frac{dx}{\sqrt{X}} &= sn^{-1} \left[\sqrt{\frac{(\beta - \delta)(x - \alpha)}{(\alpha - \delta)(x - \beta)}}, k_3 \right] \\ &= cn^{-1} \left[\sqrt{\frac{(\alpha - \beta)(x - \delta)}{(\alpha - \delta)(x - \beta)}}, k_3 \right]; \quad (27) \end{aligned}$$

and if $\alpha > x > \beta$

$$\begin{aligned} N \int_x^{\alpha} \frac{dx}{\sqrt{-X}} &= sn^{-1} \left[\sqrt{\frac{(\beta - \delta)(\alpha - x)}{(\alpha - \beta)(x - \delta)}}, k_4 \right] \\ &= cn^{-1} \left[\sqrt{\frac{(\alpha - \delta)(x - \beta)}{(\alpha - \beta)(x - \delta)}}, k_4 \right]. \quad (28) \end{aligned}$$

If $\alpha > x > \beta$,

$$\begin{aligned} N \int_{\beta}^x \frac{dx}{\sqrt{-X}} &= sn^{-1} \left[\sqrt{\frac{(\alpha - \gamma)(x - \beta)}{(\alpha - \beta)(x - \gamma)}}, k_4 \right] \\ &= cn^{-1} \left[\sqrt{\frac{(\beta - \gamma)(\alpha - x)}{(\alpha - \beta)(x - \gamma)}}, k_4 \right]; \quad (29) \end{aligned}$$

while if $\beta > x > \gamma$,

$$\begin{aligned} N \int_x^{\beta} \frac{dx}{\sqrt{X}} &= sn^{-1} \left[\sqrt{\frac{(\alpha - \gamma)(\beta - x)}{(\beta - \gamma)(\alpha - x)}}, k_3 \right] \\ &= cn^{-1} \left[\sqrt{\frac{(\alpha - \beta)(x - \gamma)}{(\beta - \gamma)(\alpha - x)}}, k_3 \right]. \quad (30) \end{aligned}$$

When x lies within the interval $\beta > x > \gamma$,

$$\begin{aligned} N \int_{\gamma}^x \frac{dx}{\sqrt{X}} &= sn^{-1} \left(\sqrt{\frac{(\beta - \delta)(x - \gamma)}{(\beta - \gamma)(x - \delta)}}, k_3 \right) \\ &= cn^{-1} \left(\sqrt{\frac{(\gamma - \delta)(\beta - x)}{(\beta - \gamma)(x - \delta)}}, k_3 \right); \quad (31) \end{aligned}$$

and when $\gamma > x > \delta$, it is seen that

$$\begin{aligned} N \int_x^\gamma \frac{dx}{\sqrt{(\alpha-x)(\beta-x)(\gamma-x)(x-\delta)}} &= sn^{-1} \left(\sqrt{\frac{(\beta-\delta)(\gamma-x)}{(\gamma-\delta)(\beta-x)}}, k_4 \right) \\ &= cn^{-1} \left(\sqrt{\frac{(\beta-\gamma)(x-\delta)}{(\gamma-\delta)(\beta-x)}}, k_4 \right). \quad (32) \end{aligned}$$

If $\gamma > x > \delta$,

$$\begin{aligned} N \int_\delta^x \frac{dx}{\sqrt{-X}} &= sn^{-1} \left(\sqrt{\frac{(\alpha-\gamma)(x-\delta)}{(\gamma-\delta)(\alpha-x)}}, k_4 \right) \\ &= cn^{-1} \left(\sqrt{\frac{(\alpha-\delta)(\gamma-x)}{(\gamma-\delta)(\alpha-x)}}, k_4 \right), \quad (33) \end{aligned}$$

and if $\delta > x > -\infty$

$$\begin{aligned} N \int_0^\delta \frac{dx}{\sqrt{X}} &= sn^{-1} \left(\sqrt{\frac{(\alpha-\gamma)(\delta-x)}{(\alpha-\delta)(\gamma-x)}}, k_3 \right) \\ &= cn^{-1} \left(\sqrt{\frac{(\gamma-\delta)(\alpha-x)}{(\alpha-\delta)(\gamma-x)}}, k_3 \right). \quad (34) \end{aligned}$$

Art. 29. By means of the above formulas it is possible to integrate the reciprocal of the square root of any cubic or biquadratic which has real roots; for example (see Byerly, *Integral Calculus*, 1902, p. 276),

$$\begin{aligned} \int_{\frac{a}{2}}^a \frac{dx}{\sqrt{(2ax-x^2)(a^2-x^2)}} &= \int_x^a \frac{dx}{\sqrt{(2a-x)(a-x)x(a+x)}} \\ &= \int_{\frac{a}{2}}^a \frac{dx}{\sqrt{(2a-x)(a-x)x(a+x)}} = \frac{1}{a} \left[sn^{-1} \left(1, \frac{\sqrt{3}}{2} \right) \right. \\ &\quad \left. - sn^{-1} \left(\frac{\sqrt{6}}{3}, \frac{\sqrt{3}}{2} \right) \right] \quad [\text{cf. (30)}] \\ &= \frac{1}{a} F \left(\frac{\sqrt{3}}{2}, \sin^{-1} 1 \right) - \frac{1}{a} F \left(\frac{\sqrt{3}}{2}, \sin^{-1} \frac{\sqrt{6}}{3} \right). \end{aligned}$$

Remark —In the above integrals it is well to note that (34), for example, may be written

$$N \int_x^\delta \frac{dx}{\sqrt{(\alpha-x)(\beta-x)(\gamma-x)(\delta-x)}},$$

showing that each factor under the root sign is positive for the interval in question.

Art. 30. It is seen that the substitution

$$\frac{\alpha-\gamma}{x-\gamma} = \frac{\beta-\gamma}{\beta-x}, \quad \text{or} \quad \frac{x-\alpha}{x-\gamma} = \frac{\beta-\gamma}{\beta-x} \quad \text{or} \quad \frac{x-\beta}{x-\gamma} = \frac{\alpha-\gamma}{\alpha-x}$$

changes

$$\int_x^\infty \frac{dx}{\sqrt{(x-\alpha)(x-\beta)(x-\gamma)}} \quad \text{into} \quad \int_\gamma^y \frac{dy}{\sqrt{(y-\alpha)(y-\beta)(y-\gamma)}},$$

or (13) into (16). For example,

$$\begin{aligned} \int_\alpha^\infty \frac{dx}{\sqrt{(x-\alpha)(x-\beta)(x-\gamma)}} &= \int_\gamma^\beta \frac{dy}{\sqrt{(y-\alpha)(y-\beta)(y-\gamma)}} \\ &= \frac{2K}{\sqrt{\alpha-\gamma}}, \quad (35) \end{aligned}$$

where $k^2 = \frac{\beta-\gamma}{\alpha-\gamma}$, see (16).

By the same substitution (14) becomes (15).

Similarly the substitution

$$\frac{\alpha-x}{\alpha-\beta} = \frac{\alpha-\gamma}{\alpha-y}, \quad \text{or} \quad \frac{x-\beta}{\alpha-\beta} = \frac{\gamma-y}{\alpha-y}, \quad \text{or} \quad \frac{x-\gamma}{\alpha-\gamma} = \frac{\beta-y}{\alpha-y}$$

changes (17) into (20) and shows that

$$\begin{aligned} \int_\beta^\alpha \frac{dx}{\sqrt{(\alpha-x)(x-\beta)(x-\gamma)}} &= \int_{-\infty}^\gamma \frac{dy}{\sqrt{(\alpha-y)(\beta-y)(\gamma-y)}} \\ &= \frac{2K'}{\sqrt{\alpha-\gamma}} \quad (36) \end{aligned}$$

where $\frac{\alpha-\beta}{\alpha-\gamma} = k^2$.

By the same substitution (18) becomes (19).

Art. 31. Let the roots of the cubic be one real and two imaginary, so that X has the form $(x-\alpha)[(x-\rho)^2+\sigma^2]$.

Make the substitution

$$y = \frac{X}{(x-\alpha)^2} = \frac{(x-\rho)^2 + \sigma^2}{x-\alpha}, \quad \text{or}$$

(1) $(x-\rho)^2 + \sigma^2 - y(x-\alpha) = 0$, which is an hyperbola.

The condition that this quadratic in x have equal roots, is

(2) $y^2 + 4(\rho-\alpha)y - 4\sigma^2 = 0$.

The roots of this equation are, say,

$$(y_1, y_2) = -2(\rho-\alpha) \pm 2\sqrt{(\rho-\alpha)^2 + \sigma^2}.$$

It is evident that y_1 is positive and y_2 is negative.

If we eliminate y from (1) and (2), we have the biquadratic

$$[(x-\rho)^2 + \sigma^2]^2 + 4(\rho-\alpha)(x-\alpha)[(x-\rho)^2 + \sigma^2] - 4\sigma^2(x-\alpha)^2 = 0,$$

the left hand side being, as we know *à priori*, a perfect square.

Equating to zero one of these double factors, we have

$$(3) \quad x^2 - 2\alpha x + 2\alpha\rho - \rho^2 - \sigma^2 = 0.$$

Further let x_1, x_2 denote the values of x which correspond to the values y_1, y_2 of y .

From (3) it follows that

$$(x_1, x_2) = \alpha \pm \sqrt{(\alpha-\rho)^2 + \sigma^2},$$

or

$$x_1 = \rho + \frac{1}{2}y_1, \quad x_2 = \rho + \frac{1}{2}y_2.$$

Further there results

$$y - y_1 = \frac{(x-x_1)^2}{x-\alpha}, \quad y - y_2 = \frac{(x-x_2)^2}{x-\alpha},$$

and

$$\frac{dy}{dx} = \frac{(x-x_1)(x-x_2)}{(x-\alpha)^2}.$$

It follows at once that

$$\begin{aligned} \int_x^\infty \frac{dx}{\sqrt{X}} &= \int_x^\infty \frac{dx}{(x-\alpha)\sqrt{y}} = \int_x^\infty \frac{(x-\alpha)dy}{(x-x_1)(x-x_2)\sqrt{y}} \\ &= \int_y^\infty \frac{dy}{\sqrt{y(y-y_1)(y-y_2)}} = \frac{2}{\sqrt{y_1-y_2}} cn^{-1} \left(\sqrt{\frac{y-y_1}{y-y_2}}, \sqrt{\frac{-y_2}{y_1-y_2}} \right) \\ &\quad (\text{cf. (13)}) = \frac{\sqrt{2}}{\sqrt{x_1-x_2}} cn^{-1} \left(\frac{x-x_1}{x-x_2}, k \right), \dots (37) \end{aligned}$$

where $k^2 = \frac{-y_2}{y_1-y_2}$ and $k'^2 = \frac{y_1}{y_1-y_2}$.

In the same way, with the same substitutions, it may be proved that

$$\begin{aligned} \int_{-\infty}^x \frac{dx}{\sqrt{(\alpha-x)[(x-\rho)^2+\sigma^2]}} &= \int_{-\infty}^y \frac{dy}{\sqrt{-y(y_1-y)(y_2-y)}} \\ &= \frac{2}{\sqrt{y_1-y_2}} cn^{-1} \left(\sqrt{\frac{y_2-y}{y_1-y}}, k' \right) \end{aligned}$$

[cf. (20), where $k'^2 = \frac{y_1}{y_1-y_2}$ is the complementary modulus of the preceding integral], or

$$\int_{-\infty}^x \frac{dx}{\sqrt{-X}} = \frac{\sqrt{2}}{\sqrt{x_1-x_2}} cn^{-1} \left(\frac{x_2-x}{x_1-x}, k' \right) \dots (38)$$

Further write $M^2 = (\rho-\alpha)^2 + \sigma^2$, so that $x_1 = \alpha + M$ and $x_2 = \alpha - M$. It is evident that

$$\begin{aligned} \int_\alpha^x \frac{dx}{\sqrt{(x-\alpha)[(x-\rho)^2+\sigma^2]}} &= \int_\infty^y \frac{dy}{\sqrt{y(y-y_1)(y-y_2)}} \\ &= \frac{\sqrt{2}}{\sqrt{x_1-x_2}} cn^{-1} \left(\frac{x_1-x}{x-x_2}, k \right), \text{ cf. (37),} \\ &= \frac{1}{\sqrt{M}} cn^{-1} \left[\frac{M-(x-\alpha)}{M+(x-\alpha)}, k \right], k^2 = \frac{1}{2} - \frac{1}{2} \frac{\alpha-\rho}{M}. \dots (39) \end{aligned}$$

Similarly, it may be shown that

$$\int_x^\alpha \frac{dx}{\sqrt{(\alpha-x)[(x-\rho)^2+\sigma^2]}} = \frac{1}{\sqrt{M}} cn^{-1} \left(\frac{M-(\alpha-x)}{M+(\alpha-x)}, k' \right), \quad (40)$$

where

$$k'^2 = \frac{1}{2} + \frac{1}{2} \frac{\alpha-\rho}{M}.$$

Note that the modulus here is the complementary modulus of the one in (39) and that the product of the two moduli is, say,

$$2kk' = \frac{\sigma}{M}.$$

As numerical examples, prove that

$$\int_x^\infty \frac{dx}{\sqrt{x^3-1}} = \frac{1}{\sqrt[4]{3}} cn^{-1} \left(\frac{x-1-\sqrt{3}}{x-1+\sqrt{3}}, k_1 \right),$$

$$\int_1^x \frac{dx}{\sqrt{x^3-1}} = \frac{1}{\sqrt[4]{3}} cn^{-1} \left(\frac{\sqrt{3}+1-x}{\sqrt{3}-1+x}, k_1 \right),$$

$$\int_x^1 \frac{dx}{\sqrt{1-x^3}} = \frac{1}{\sqrt[4]{3}} cn^{-1} \left(\frac{\sqrt{3}-1+x}{\sqrt{3}+1-x}, k_2 \right),$$

$$\int_{-\infty}^x \frac{dx}{\sqrt{1-x^3}} = \frac{1}{\sqrt[4]{3}} cn^{-1} \left(\frac{1-x-\sqrt{3}}{1-x+\sqrt{3}}, k_2 \right),$$

where $2k_1k_2 = \frac{1}{2} = \sin 30^\circ$, $k_1 = \sin 15^\circ$, $k_2 = \sin 75^\circ$.

(Greenhill, loc. cit., p. 40.)

Art. 32. Suppose next that we have a quartic with two imaginary roots. It is always possible to write

$$X = (ax^2 + 2bx + c)(Ax^2 + 2Bx + C),$$

where the real roots constitute the first factor, and the imaginary roots the second so that $b^2 - ac$ is positive and $B^2 - AC$ is negative.

Make the substitution

$$y = \frac{ax^2 + 2bx + c}{Ax^2 + 2Bx + C} = \frac{N}{D}, \text{ say, } \dots \dots \dots (i)$$

or

$$(a) \quad x^2(Ay-a) + 2x(By-b) + Cy-c = 0.$$

This equation has equal roots in x , if

$$(b) \quad (By-b)^2 - (Ay-a)(Cy-c) = 0.$$

Let the roots of this equation be y_1 and y_2 .

From (a) it is seen that

$$[2x(By-b)]^2 = x^4(Ay-a)^2 + 2x^2(Ay-a)(Cy-c) + (Cy-c)^2,$$

which combined with (b), gives

$$(c) \quad -x = \frac{Cy-c}{By-b} = \frac{By-b}{Ay-a}, \quad Ax+B = \frac{Ab-aB}{Ay-a},$$

$$(d) \quad y = \frac{ax+b}{Ax+B} = \frac{bx+c}{Bx+C}, \quad Ay-a = \frac{(Ab-aB)x+Ac-aC}{Bx+C}.$$

From (i) it follows, if D is put for $Ax^2+2Bx+C$, and since $Ax_1^2+2Bx_1+C \equiv x_1(Ax_1+B)+Bx_1+C$, that

$$y_1 - y = \frac{x-x_1}{D} \frac{2(Ab-aB)xx_1 + (Ac-aC)(x+x_1) + 2(Bc-bC)}{x_1(Ax_1+B) + (Bx_1+C)},$$

which, see (c) and (d),

$$= \frac{x-x_1}{D} A(y_1-a) \frac{x\{2(Ab-aB)x_1+Ac-aC\} + x_1(Ac-aC) + 2(Bc-bC)}{x_1(Ab-aB) + x_1(Ab-aB) + Ac-aC},$$

so that

$$y_1 - y = \frac{x-x_1}{D} (Ay_1-a)(x-x_1);$$

and similarly

$$y - y_2 = \frac{(a-Ay_2)(x-x_2)^2}{D}$$

and

$$\frac{dy}{dx} = \frac{2(Ab-aB)(x_1-x)(x-x_2)}{D^2}.$$

It follows that

$$\begin{aligned} & \frac{dx}{\sqrt{(ax^2+2bx+c)(Ax^2+2Bx+C)}} \\ &= \frac{dy}{D\sqrt{y}} = \frac{Ddy}{2(Ab-Ba)(x_1-x)(x-x_2)\sqrt{y}} \\ &= \frac{\sqrt{(Ay_1-a)(a-Ay_2)}}{2(Ab-aB)} \frac{dy}{\sqrt{y(y_1-y)(y-y_2)}}. \end{aligned}$$

Noting that

$$(Ay_1-a)(a-Ay_2) = -A^2y_1y_2 + Aa(y_1+y_2) - a^2 = \frac{(Ab-aB)^2}{AC-B^2},$$

it follows that

$$(e) \quad \frac{dx}{\sqrt{X}} = \frac{1}{\sqrt{AC-B^2}} \frac{dy}{\sqrt{4y(y_1-y)(y-y_2)}}.$$

From (b) it is seen that $y_1 > 0$ and $y_2 < 0$, and from (e) it is evident that y varies from 0 to y_1 for real values of \sqrt{X} . Hence, see (17),

$$\int_x^{x_1} \frac{dx}{\sqrt{X}} = \frac{1}{2\sqrt{AC-B^2}} \int_y^{y_1} \frac{dy}{\sqrt{y(y_1-y)(y-y_2)}},$$

or,

$$\sqrt{y_1-y_2} \sqrt{AC-B^2} \int_x^{x_1} \frac{dx}{\sqrt{X}} = sn^{-1} \left(\sqrt{\frac{y_1-y}{y_1}}, k \right) = cn^{-1} \left(\sqrt{\frac{y}{y_1}}, k \right) \quad (41)$$

where $k^2 = \frac{y_1}{y_1-y_2}$ and $k'^2 = \frac{-y_2}{y_1-y_2}$.

Art. 33. Suppose next in the quartic

$$X = (ax^2+2bx+c)(Ax^2+2Bx+C),$$

that all the roots are imaginary so that $b^2-ac < 0$ and $B^2-AC < 0$. In this case the roots y_1 and y_2 of the equation of the preceding article

$$(AC-B^2)y^2 - (Ac+aC-2Bb)y + ac - b^2 = 0$$

are both positive.

Hence the integral of the equation (e) may be written [cf. (17)] in the form

$$\begin{aligned} \sqrt{AC-B^2} \int_x^{x_1} \frac{dx}{\sqrt{X}} &= \frac{1}{2} \int_v^{v_1} \frac{dy}{\sqrt{-y(y-y_1)(y-y_2)}} \\ &= \frac{1}{\sqrt{y_1}} sn^{-1} \left(\sqrt{\frac{y_1-y}{y_1-y_2}}, k \right) = \frac{1}{\sqrt{y_1}} cn^{-1} \left(\sqrt{\frac{y-y_2}{y_1-y_2}}, k \right) \\ &= \frac{1}{\sqrt{y_1}} dn^{-1} \left(\sqrt{\frac{y}{y_1}}, k \right) \dots \dots \dots (42) \end{aligned}$$

where

$$k^2 = 1 - \frac{y_2}{y_1}, \quad k'^2 = \frac{y_2}{y_1}$$

and where y oscillates between the two positive values y_1 and y_2 .

Art. 34. As an example of the preceding article, let

$$X = x^4 + 2v^2x^2 \cos 2\omega + v^4 = (x^2 + 2vx \sin \omega + v^2)(x^2 - 2vx \sin \omega + v^2).$$

If we put

$$y = \frac{x^2 + 2vx \sin \omega + v^2}{x^2 - 2vx \sin \omega + v^2},$$

it is seen that

$$y_1 = \tan^2 \left(\frac{\pi}{4} + \frac{\omega}{2} \right), \quad y_2 = \tan^2 \left(\frac{\pi}{4} - \frac{\omega}{2} \right), \quad x_1 = v, \quad x_2 = -v,$$

$$k = \frac{1 - \sin \omega}{1 + \sin \omega} = \tan^2 \left(\frac{\pi}{4} - \frac{\omega}{2} \right),$$

and

$$\begin{aligned} \int_x^v \frac{dx}{\sqrt{x^4 + 2v^2x^2 \cos 2\omega + v^4}} \\ = \frac{1}{v(1 + \sin \omega)} dn^{-1} \sqrt{\frac{1 - \sin \omega}{1 + \sin \omega} \cdot \frac{x^2 + 2vx \sin \omega + v^2}{x^2 - 2vx \sin \omega + v^2}} \end{aligned} \quad (43)$$

When $\omega = \frac{\pi}{4}$, $v = 1$, the preceding equation becomes

$$\int_x^1 \frac{dx}{\sqrt{1+x^4}} = (2 - \sqrt{2}) dn^{-1} \left\{ (\sqrt{2} - 1) \sqrt{\frac{x^2 + \sqrt{2}x + 1}{x^2 - \sqrt{2}x + 1}}, k \right\} \quad (44)$$

where $k = (\sqrt{2} - 1)^2$.

For the substitution $\frac{x^2}{v^2} = \frac{1+z}{1-z}$, there results

$$\int_x^\infty \frac{dx}{\sqrt{x^4 + 2v^2x^2 \cos 2\omega + v^4}} = \frac{1}{2v} \int_z^1 \frac{dz}{\sqrt{(1-z^2)(\cos^2 \omega + z^2 \sin^2 \omega)}},$$

which, see (2),

$$= \frac{1}{2v} \operatorname{cn}^{-1}(z, \sin \omega) = \frac{1}{2v} \operatorname{cn}^{-1}\left(\frac{x^2 - v^2}{x^2 + v^2}, \sin \omega\right).$$

If in this formula we put $\omega = \frac{1}{4}\pi$ and $v = 1$, we have

$$\int_x^\infty \frac{dx}{\sqrt{x^4 + 1}} = \frac{1}{2} \operatorname{cn}^{-1}\left(\frac{x^2 - 1}{x^2 + 1}, \frac{1}{2}\sqrt{2}\right),$$

$$\int_0^x \frac{dx}{\sqrt{1 + x^4}} = \frac{1}{2} \operatorname{cn}^{-1}\left(\frac{1 - x^2}{1 + x^2}, \frac{1}{2}\sqrt{2}\right).$$

Art. 35. It was shown above that the substitution

$$\sin^2 \phi = \frac{1 - x^2}{1 - k^2 x^2}$$

transforms the integral

$$(A) \quad \int_x^1 \frac{dx}{\sqrt{(1-x^2)(1-k^2x^2)}} \text{ into } \operatorname{sn}^{-1}\left(\sqrt{\frac{1-x^2}{1-k^2x^2}}, k\right).$$

On the other hand

$$(B) \quad \int_x^1 \frac{dx}{\sqrt{(1-x^2)(1-k^2x^2)}} = \int_0^1 \frac{dx}{\sqrt{(1-x^2)(1-k^2x^2)}} - \int_0^x \frac{dx}{\sqrt{(1-x^2)(1-k^2x^2)}} = K - u_1$$

where

$$u = \int_0^x \frac{dx}{\sqrt{(1-x^2)(1-k^2x^2)}}.$$

It follows that

$$\operatorname{sn}^{-1} \sqrt{\frac{1-x^2}{1-k^2x^2}} = K - \operatorname{sn}^{-1} x,$$

a relation among the integrals. It is also at once evident that

$$\sqrt{\frac{1-x^2}{1-k^2x^2}} = \operatorname{sn}(K-u), \quad \text{or} \quad \frac{cn u}{dn u} = \operatorname{sn}(K-u),$$

which is a relation among the functions.

In (A) make $k=0$, and then

$$\int_0^1 \frac{dx}{\sqrt{1-x^2}} = \sin^{-1} \sqrt{1-x^2},$$

and from (B) it is seen that

$$\int_x^1 \frac{dx}{\sqrt{1-x^2}} = \int_0^1 \frac{dx}{\sqrt{1-x^2}} - \int_0^x \frac{dx}{\sqrt{1-x^2}} = \frac{\pi}{2} - u,$$

if

$$u = \int_0^x \frac{dx}{\sqrt{1-x^2}} = \sin^{-1} x.$$

Hence

$$\sin^{-1} \sqrt{1-x^2} = \frac{\pi}{2} - \sin^{-1} x.$$

a relation among the integrals; and on the other hand it is seen that

$$\sqrt{1-\sin^2 u} = \sin\left(\frac{\pi}{2} - u\right),$$

a relation among the functions.

It is thus made evident that we may study the nature of the elliptic functions and their characteristic properties directly from their associated integrals just as we may study the properties of the circular, hyperbolic, logarithmic and exponential functions from their associated integrals. This should be emphasized both in the study of the elementary calculus and in the theory of elliptic integrals and elliptic functions.

Art. 36. In the applications of the elementary calculus it was often necessary to evaluate such integrals as $\int \sin u \, du$; so here we must study the integrals of the most usual elliptic functions. From the integral $u = \int_0^\phi \frac{d\phi}{\Delta\phi}$, it is seen at once that

$du = \frac{d\phi}{\Delta\phi}$, or $dn u du = d\phi$, so that $d am u = dn u du$, $d sn u = cn u dn u du$, $d cn u = -sn u dn u du$, $d dn u = -k^2 cn u sn u du$. We further note that

$$sn^2 u + cn^2 u = 1, \quad dn^2 u - k'^2 = k^2 cn^2 u, \quad dn^2 u + k^2 sn^2 u = 1.$$

We have without difficulty

$$\int sn u du = -\frac{1}{k^2} \int \frac{-k^2 sn u cn u du}{cn u} = -\frac{1}{k} \int \frac{dv}{\sqrt{v^2 - k'^2}},$$

(if $v = dn u$). The last integral is

$$-\frac{1}{k} \log(v + \sqrt{v^2 - k'^2}) = -\frac{1}{k} \cosh^{-1} \frac{v}{k'} = -\frac{1}{k} \cosh^{-1} \left(\frac{dn u}{k'} \right).$$

Further since $dn K = k'$, Art. 17, we have

$$k \int_u^K sn u du = \cosh^{-1} \left(\frac{dn u}{k'} \right) = \sinh^{-1} \left(k \frac{cn u}{k'} \right) = \log \frac{dn u + k cn u}{k'}.$$

Similarly it may be proved that

$$k \int_0^u cn u du = \cos^{-1}(dn u) = \sin^{-1}(k sn u),$$

and

$$\int_0^u dn u du = \phi = am u = \sin^{-1} sn u = \cos^{-1} cn u.$$

Art. 37. The following integrals should be noted:

$$\int \frac{du}{sn u} = \int \frac{sn u cn u dn u du}{sn^2 u cn u dn u} = \frac{1}{2} \int \frac{dv}{v \sqrt{(1-v)(1-k^2v)}} \quad (\text{if } v = sn^2 u).$$

Further writing $\sqrt{(1-v)(1-k^2v)} = (1-v)z$, the last integral becomes

$$\begin{aligned} & -\frac{1}{2} \log \left[\frac{\sqrt{(1-v)(1-k^2v)} + 1}{v} - \frac{1+k^2}{2} \right] - \frac{1}{2} \log \frac{1-k^2}{2} \\ & = -\frac{1}{2} \log \left[\frac{cn u dn u + 1}{sn^2 u} - \frac{1+k^2}{2} \right] + C \\ & = -\frac{1}{2} \log \left[\frac{2cn u dn u + cn^2 u + dn^2 u}{2sn^2 u} \right] + C, \end{aligned}$$

so that, omitting C ,

$$\int \frac{du}{sn u} = \log \left[\frac{sn u}{cn u + dn u} \right],$$

where the arbitrary constant is omitted. Similarly it may be shown that

$$\int \frac{du}{cn u} = \frac{1}{k'} \log \left[\frac{k' sn u + dn u}{cn u} \right],$$

and that

$$\int \frac{du}{dn u} = \frac{1}{2k'} \sin^{-1} \left[\frac{k'^2 sn^2 u - cn^2 u}{dn^2 u} \right].$$

Further by definition $E(k, \phi) = \int_0^\phi \Delta \phi d\phi$ (cf. Art. 5), or since $\phi = am u$ and $d am u = dn u du$,

$$E(am u) = \int_0^u dn^2 u du.$$

It follows that

$$\int_0^u sn^2 u du = \frac{1}{k^2} [u - E(am u, k)],$$

and

$$\int_0^u cn^2 u du = \frac{1}{k^2} [E(am u, k) - k'^2 u].$$

Art. 38. Reduction formulas. The following is a very useful and a very general reduction formula.* Consider the identity

$$\begin{aligned} (m + \sin^2 \phi)^\mu \sin \phi \cos \phi \Delta \phi &= \int_0^\phi \frac{d}{d\phi} \{ (m + \sin^2 \phi)^\mu \sin \phi \cos \phi \Delta \phi \} d\phi \\ &= \int_0^\phi \{ 2\mu (m + \sin^2 \phi)^{\mu-1} \sin^2 \phi \cos^2 \phi \Delta^2 \phi \\ &\quad + (m + \sin^2 \phi)^\mu [\cos^2 \phi \Delta^2 \phi - \sin^2 \phi \Delta^2 \phi - k^2 \sin^2 \phi \cos^2 \phi] \} \frac{d\phi}{\Delta \phi}. \end{aligned}$$

In this expression put $m + \sin^2 \phi = v$, so that $\sin^2 \phi = v - m$, $\cos^2 \phi = 1 - v + m$, $\Delta^2 \phi = 1 - k^2 v + k^2 m$, and writing

$$V_\mu = \int_0^\phi \frac{v^\mu d\phi}{\Delta \phi} = \int_0^\phi \frac{(m + \sin^2 \phi)^\mu d\phi}{\Delta \phi},$$

* See, for example, Durège, *Elliptische Funktionen*, § 4, Second edition.

then there is found

$$(m + \sin^2 \phi)^\mu \sin \phi \cos \phi \Delta \phi = -2\mu A V_{\mu-1} + (2\mu + 1) B V_\mu \\ - (2\mu + 2) C V_{\mu+1} + (2\mu + 3) k^2 V_{\mu+2}, \quad \dots \quad (i)$$

where $A = m(1+m)(1+k^2m)$;

$$B = 1 + 2m + 2k^2m + 3k^2m^2;$$

$$C = 1 + k^2 + 3k^2m.$$

From this formula it is evident that every integral V_μ may be expressed through the three integrals V_0, V_1, V_{-1} , the latter being forms of integrals which in Chapter I have been called *elliptic integrals of the first, second and third kinds* respectively.

The following formulas may be derived immediately from the formula above, by writing

$$S_m(u) = \int sn^m u \, du, \quad C_m(u) = \int cn^m u \, du, \quad D_m(u) = \int dn^m u \, du,$$

$$(n+1)k^2 S_{n+2}(u) - n(1+k^2)S_n(u) + (n-1)S_{n-2}(u) \\ = sn^{-1}u \, cn \, u \, dn \, u, \quad \dots \quad (ii)$$

$$(n+1)k^2 C_{n+2}(u) + n(k'^2 - k^2)C_n(u) - (n-1)k'^2 C_{n-2}(u) \\ = cn^{-1}u \, sn \, u \, dn \, u, \quad \dots \quad (iii)$$

$$(n+1)D_{n+2}(u) - n(1+k'^2)D_n(u) + (n-1)k'^2 D_{n-2}(u) \\ = k^2 dn^{-1}u \, sn \, u \, cn \, u. \quad \dots \quad (iv)$$

In particular, if $u = K$ say in (ii), there results

$$(n+1)k^2 S_{n+2}(K) - n(1+k^2)S_n(K) + (n-1)S_{n-2}(K) = 0,$$

which is the analogue of Wallis's formula for $\int_0^{\frac{\pi}{2}} \sin^n \theta \, d\theta$.

Art. 39. It may be noted that any of the quantities $F(\sin^2 \phi)$, $F(\cos^2 \phi)$, $F(\tan^2 \phi)$, where F is a rational function of its argument, may be expressed through an aggregate of terms of the form $M(m + \sin^2 \phi)^\mu$, where μ is a positive or negative integer or zero and where M and m are real or imaginary constants.

Further by writing $x = \frac{a+bz}{c+dz}$, where $z = \sin \phi$, or $z = \cos \phi$,

or $z = \tan \phi$, it is seen that the general elliptic integral of Art. 5, namely, $\int \frac{Q(x)dx}{\sqrt{R(x)}}$ may be put in the form $\int \frac{F(\sin^2 \phi)d\phi}{\Delta\phi}$, which in turn may be expressed through integrals that correspond to the integrals V_0 , V_1 and V_{-1} of the preceding article.

Art. 40. Returning to formula (i) above, make $\mu = -1$, and note that if $m = 0$, we have $A = 0$, $B = 1$; the formula becomes

$$(a) \quad \cot \phi \Delta\phi = - \int \frac{1}{\sin^2 \phi} \frac{d\phi}{\Delta\phi} + k^2 \int \frac{\sin^2 \phi d\phi}{\Delta\phi}.$$

Next let $m = -1$, so that $A = 0$, $B = -k'^2$, and we have

$$(b) \quad -\tan \phi \Delta\phi = -k'^2 \int \frac{1}{\cos^2 \phi} \frac{d\phi}{\Delta\phi} - k^2 \int \frac{\cos^2 \phi d\phi}{\Delta\phi};$$

finally let $m = -\frac{1}{k^2}$, so that $A = 0$, $B = \frac{k'^2}{k^2}$, and the reduction formula is

$$(c) \quad -\frac{k^2 \sin \phi \cos \phi}{\Delta\phi} = k'^2 \int \frac{1}{\Delta^2 \phi} \frac{d\phi}{\Delta\phi} - \int \Delta\phi d\phi.$$

Art. 41. Legendre, *Traité, etc.*, I, p. 256, offers the following integrals "which are often met with in the application of the elliptic integrals." These may for the most part be derived at once from the formulas given above.

$$\int_0^\phi \frac{d\phi}{\Delta\phi} = F(k, \phi), \quad \text{where } \Delta\phi = \sqrt{1 - k^2 \sin^2 \phi} = \Delta,$$

$$\int_0^\phi \Delta d\phi = E(k, \phi), \quad \text{or } \int_0^u dn^2 u du = E(u), \quad \text{since } d\phi = dn u du.$$

$$\int_0^\phi \frac{d\phi}{\Delta^3} = \frac{1}{k'^2} E(k, \phi) - \frac{k^2 \sin \phi \cos \phi}{k'^2 \Delta}, \quad \text{or}$$

$$\int_0^u \frac{du}{dn^2 u} = \frac{E(u)}{k'^2} - \frac{k^2 sn u cn u}{k'^2 dn u},$$

$$\int_0^\phi \frac{d\phi \sin^2 \phi}{\Delta} = \frac{1}{k^2} [F(k, \phi) - E(k, \phi)], \quad \text{or}$$

$$\int_0^u sn^2 u \, du = \frac{u - E(u)}{k^2},$$

$$\int_0^\phi \frac{d\phi \cos^2 \phi}{\Delta} = \frac{1}{k^2} [E(k, \phi) - k'^2 F(k, \phi)], \text{ or}$$

$$\int_0^u cn^2 u \, du = \frac{-k'^2 u + E(u)}{k^2}.$$

$$\int_0^\phi \frac{d\phi}{\Delta \cos^2 \phi} = \frac{1}{k'^2} [\Delta \tan \phi + k'^2 F(k, \phi) - E(k, \phi)], \text{ or}$$

$$\int_0^u \frac{du}{cn^2 u} = \frac{tn \, u \, dn \, u + k'^2 u - E(u)}{k'^2},$$

$$\int_0^\phi \frac{d\phi \tan^2 \phi}{\Delta} = \frac{\Delta \tan \phi - E(k, \phi)}{k'^2}, \text{ or}$$

$$\int_0^u tn^2 u \, du = \frac{dn \, u \, tn \, u - E(u)}{k'^2}.$$

$$\int_0^\phi \frac{d\phi \cos^2 \phi}{\Delta^3} = \frac{1}{k^2} [F(k, \phi) - E(k, \phi)] + \frac{\sin \phi \cos \phi}{\Delta},$$

$$\int_0^\phi \frac{d\phi \sin^2 \phi}{\Delta^3} = \frac{1}{k^2 k'^2} [E(k, \phi) - k'^2 F(k, \phi)] - \frac{\sin \phi \cos \phi}{k'^2 \Delta},$$

$$\int_0^\phi \frac{\Delta \, d\phi}{\cos^2 \phi} = \Delta \tan \phi + F(k, \phi) - E(k, \phi),$$

$$\int_0^\phi \Delta \tan^2 \phi \, d\phi = \Delta \tan \phi + F(k, \phi) - 2E(k, \phi),$$

$$\int_0^\phi \Delta^3 d\phi = \frac{k^2}{3} \Delta \sin \phi \cos \phi + \frac{2+2k'^2}{3} E(k, \phi) - \frac{k'^2}{3} F(k, \phi),$$

$$\int_0^\phi \Delta \sin^2 \phi \, d\phi = \frac{-1}{3} \Delta \sin \phi \cos \phi + \frac{2k^2-1}{3k^2} E(k, \phi) + \frac{k'^2}{3k^2} F(k, \phi),$$

$$\int_0^\phi \Delta \cos^2 \phi \, d\phi = \frac{1}{3} \Delta \sin \phi \cos \phi + \frac{1+k^2}{3k^2} E(k, \phi) - \frac{k'^2}{3k^2} F(k, \phi).$$

To these may be added

$$\int_\phi^{\frac{\pi}{2}} \frac{d\phi}{\sin^2 \phi \Delta} = \cot \phi \Delta \phi + K - E_1 - F(k, \phi) + E(k, \phi), \text{ or}$$

$$\int_u^K \frac{du}{sn^2u} = \cot am u \, dn u + K - E_1 - u + E(u),$$

$$\int_u^K \frac{du}{tn^2u} = \cot am u \, dn u - E_1 + E(u), \text{ or}$$

$$\int_\phi^{\frac{\pi}{2}} \frac{d\phi}{\tan^2 \phi \, \Delta} = \int_\phi^{\frac{\pi}{2}} \frac{1 - \sin^2 \phi}{\sin^2 \phi} \frac{d\phi}{\Delta \phi}.$$

EXAMPLES

1. Show that

$$\int_x^1 \frac{dx}{\sqrt{1-x^4}} = \frac{1}{2} \sqrt{2} \, cn^{-1} \left(x, \frac{1}{2} \sqrt{2} \right),$$

$$\int_1^x \frac{dx}{\sqrt{x^4-1}} = \frac{1}{2} \sqrt{2} \, cn^{-1} \left(\frac{1}{x}, \frac{1}{2} \sqrt{2} \right).$$

2. Show that

$$\int_0^1 \sqrt{1-x^4} dx = 2\sqrt{2} \int_0^K (dn^2x - dn^4x) dx = \frac{\sqrt{2}}{3} K \left(\text{mod} \frac{\sqrt{2}}{2} \right) = 0.87401 \dots$$

3. Show that $\int_0^b \sqrt{\frac{a^2-bx}{bx-x^2}} dx = 2a \int_0^K dn^2x dx = 2aE\left(\frac{b}{a}, \frac{\pi}{2}\right).$

4. Show that $\int_0^K \frac{sn u \, du}{dn u + k'} = \frac{1}{k'(1+k')}.$

5. If $u = \int_0^b \sqrt{(a^2-x^2)(b^2-x^2)} dx$, write $y = sn^{-1}\left(\frac{x}{b}, \frac{b}{a}\right)$, cf. formula (5a), and show that

$$u = ab^2 \int_0^K cn^2y \, dn^2y \, dy = \frac{1}{3} a \left[(a^2+b^2)E\left(\frac{b}{a}, \frac{\pi}{2}\right) - (a^2-b^2)K \right], \left(\text{mod.} \frac{b}{a} \right).$$

Byerly.

6. Show that for the inverse functions,

(i) $\int sn^{-1}u \, du = u \, sn^{-1}u + \frac{1}{k} \cosh \left(\frac{\sqrt{1-k^2u^2}}{k'} \right);$

(ii) $\int cn^{-1}u \, du = u \, cn^{-1}u - \frac{1}{k} \cos^{-1}(\sqrt{k'^2+k^2u^2});$

(iii) $\int dn^{-1}u \, du = u \, dn^{-1}u - \sin^{-1} \left(\frac{\sqrt{1-u^2}}{k} \right).$

7. Note that if $X = ax^2 + 2bx + c$,

$$d[x^p \sqrt{X}] = \frac{a(p+1)x^{p+1} + b(2p+1)x^p + cp x^{p-1}}{\sqrt{X}} dx;$$

or, if we put $v_p = \int \frac{x^p dx}{\sqrt{X}}$, we have

$$x^p \sqrt{X} = a(p+1)v_{p+1} + b(2p+1)v_p + cp v_{p-1}.$$

Further, if $t = sn^2 u$, it is seen that

$$\int sn^m u \, du = \frac{1}{2} \int \frac{t^{\frac{m-1}{2}} dt}{\sqrt{(1-t)(1-k^2 t)}}.$$

Derive the reduction formulas (ii), (iii), (iv) of Art. 38.

8. Prove that
$$\int \frac{dS}{\frac{x^2}{a^2} + \frac{y^2}{b^2} + \frac{z^2}{c^2}} = \frac{4\pi abc}{\sqrt{a^2 - c^2}} cn^{-1} \left(\frac{c}{a}, \sqrt{\frac{a^2 - b^2}{a^2 - c^2}} \right),$$

where the integration is taken over the surface S of a sphere $x^2 + y^2 + z^2 = r^2$.

Burnside, Math. Tripos, 1881

9. Show that

$$\int \frac{sn \, u}{cn \, u} \, du = \frac{1}{k'} \log \frac{dn \, u + k'}{cn \, u},$$

$$\int \frac{cn \, u}{sn \, u} \, du = \log \frac{1 - dn \, u}{sn \, u},$$

$$\int \frac{sn \, u}{cn \, u \, dn \, u} \, du = \frac{1}{k'^2} \log \frac{dn \, u}{cn \, u},$$

$$\int \frac{cn \, u}{sn^2 \, u} \, du = -\frac{dn \, u}{sn \, u},$$

$$\int \frac{sn \, u}{cn^2 \, u} \, du = -\frac{1}{k'^2} \frac{dn \, u}{cn \, u}.$$

CHAPTER IV

THE NUMERICAL COMPUTATION OF THE ELLIPTIC INTEGRALS OF THE FIRST AND SECOND KINDS. LANDEN'S TRANSFORMATIONS

Art. 42. With Jacobi* consider two fixed circles as in Fig. 15 and suppose that R is the radius of the larger circle and r the radius of the smaller circle. Let the distance $OQ=l$. From any point B on the large circle draw a tangent to the small

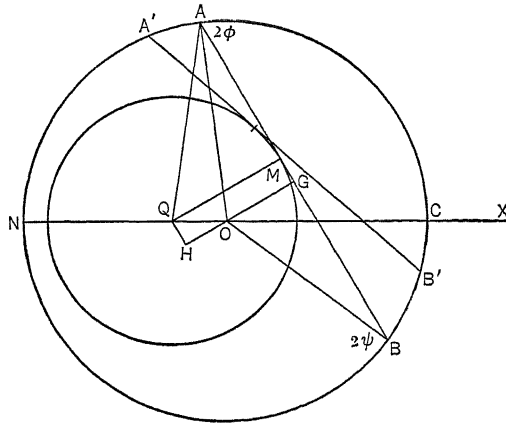

FIG. 15.

circle which again cuts the large circle in A . Denote the azimuth angle BOX by 2ψ and AOX by 2ϕ . OG is drawn perpendicular to AB and its length is denoted by p . Note that the angle $GOX = \phi - \psi$ and $GOB = \phi + \psi$, $p = R \cos(\phi + \psi)$ and $QM = r = p + OH = R \cos(\phi + \psi) + l \cos(\phi - \psi)$, or

$$r = (R + l) \cos \phi \cos \psi - (R - l) \sin \phi \sin \psi.$$

* Jacobi, *Crelle's Journal*, Vol. III, p. 376, 1828; see also Cayley's *Elliptic Functions*, p. 28.

When $\psi = 0$, let the corresponding value of ϕ be μ , so that

$$r = (R+l) \cos \mu, \text{ or } \cos \mu = \frac{r}{R+l}, \sin \mu = \frac{\sqrt{(R+l)^2 - r^2}}{R+l}.$$

Denote the ratio $\frac{QN}{QC}$ by $\Delta\mu$, so that $\Delta\mu = \frac{R-l}{R+l}$; then since

$$\Delta\mu^2 = 1 - k^2 \sin^2 \mu, \text{ it is seen that } k^2 = \frac{4lR}{(R+l)^2 - r^2}.$$

Returning to the figure, it is seen that

$$\begin{aligned} \overline{AM}^2 &= \overline{AQ}^2 - \overline{MQ}^2 = R^2 + l^2 + 2Rl \cos 2\phi - r^2 \\ &= (R+l)^2 - r^2 - 4lR \sin^2 \phi; \end{aligned}$$

or

$$\overline{AM}^2 = \{(R+l)^2 - r^2\} \Delta^2 \phi;$$

and similarly

$$\overline{BM}^2 = \{(R+l)^2 - r^2\} \Delta^2 \psi.$$

If the tangent is varied, its new position becoming $A'B'$, consecutive to the initial position, then clearly we have

$$AA' : BB' = AM : BM;$$

or

$$\frac{d\phi}{AM} + \frac{d\psi}{BM} = 0;$$

and if for AM and BM their values be substituted, it follows that

$$\frac{d\phi}{\Delta\phi} + \frac{d\psi}{\Delta\psi} = 0.$$

Suppose that the smaller circle is varied, the centre moving along the X -axis while r and l are subjected to the condition

$$k^2 = \frac{4lR}{(R+l)^2 - r^2}, \text{ } k \text{ being constant.}$$

In particular when the smaller circle reduces to the point circle at L , as in Fig. 16, then

$$r=0, \quad OL=l \text{ and } k^2 = \frac{4lR}{(R+l)^2}.$$

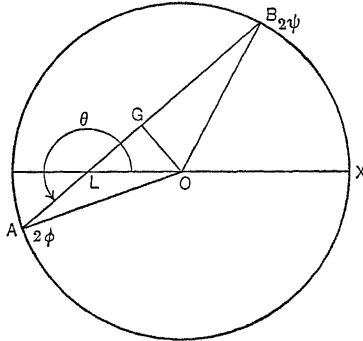

FIG. 16.

Let θ represent the angle XLA . It is seen that

$$\theta = \frac{\pi}{2} + \phi + \psi,$$

and consequently $d\theta = d\phi + d\psi$.

It is also seen that the angle $LAO = \theta - 2\phi$ and $GOX = \phi + \psi$. From the triangle ALO it follows at once that

$$l \sin \theta = R \sin (2\phi - \theta). \quad \dots \dots \dots (1)$$

The relation $\frac{d\phi}{AM} + \frac{d\psi}{BM} = 0$, becomes here

$$\frac{d\phi}{AM} = \frac{d\psi}{BM} = \frac{d\theta}{2AG};$$

or, since

$$\overline{AG}^2 = R^2 - l^2 \cos^2 (180 - \phi - \psi) = R^2 - l^2 \sin^2 \theta,$$

it follows that

$$\frac{d\phi}{\Delta\phi} = \frac{d\theta (R+l)}{2\sqrt{R^2 - l^2 \sin^2 \theta}}. \quad \dots \dots \dots (2)$$

Formula (1) may be regarded as the algebraic integral* of (2), or (2) may be considered as being produced by the transformation (1).

Write $k_1 = \frac{l}{R}$ and put ϕ_1 in the place of θ .

It is seen that

$$k = \frac{2\sqrt{lR}}{R+l} = \frac{2\sqrt{k_1}}{1+k_1}, k' = \frac{1-k_1}{1+k_1}, k_1 = \frac{1-k'}{1+k'}, \dots \quad (3)$$

and

$$\frac{d\phi}{\Delta(k, \phi)} = \frac{1}{2}(1+k_1) \frac{d\phi_1}{\Delta(k_1, \phi_1)}, \dots \quad (2')$$

$$k_1 \sin \phi_1 = \sin (2\phi - \phi_1). \dots \quad (1')$$

The last expression may be written

$$k_1 \sin (\phi_1 - \phi + \phi) = \sin (\phi - \phi_1 + \phi),$$

from which we have at once

$$\tan (\phi_1 - \phi) = \frac{1-k_1}{1+k_1} \tan \phi = k' \tan \phi, \dots \quad (3)$$

or

$$\tan \phi_1 = \frac{(1+k') \tan \phi}{1-k' \tan^2 \phi}, \sin \phi_1 = \frac{(1+k') \sin \phi \cos \phi}{\Delta(k, \phi)}$$

Art. 43. It is seen that $k_1 = \frac{l}{r} < 1$ and since $\frac{2\sqrt{k_1}}{1+k_1} > k_1$, it follows that $k > k_1$. From (1') it is seen that $0 < \phi < \phi_1$, if $\phi \leq \frac{\pi}{2}$.

From (2') it is seen that

$$\begin{aligned} F(k, \phi) &= \frac{1}{2}(1+k_1)F(k_1, \phi_1) \\ &= (1+k_1)(1+k_2) \dots (1+k_n) \frac{F(k_n, \phi_n)}{2^n}, \dots \quad (A) \end{aligned}$$

* John Landen, An investigation of a general theorem for finding the length of an arc of any conic, etc., Phil. Trans. 65 (1775), pp. 283, et. seq; or *Mathematical Memoirs* I, p. 32 of John Landen (London, 1780). An article by Cayley on John Landen is given in the Encyc. Brit., Eleventh Edition, Vol. XVI, p. 153. See also Lagrange, *Œuvres*, II, p. 253; Legendre, *Traité*, etc., I, p. 89.

where the moduli are decreasing and the amplitudes are increasing.

It is also seen that

$$k_v = \frac{1 - \sqrt{1 - k_{v-1}^2}}{1 + \sqrt{1 - k_{v-1}^2}}, \quad \left(\begin{array}{l} v = 1, 2, \dots, n \\ k_0 = k \end{array} \right),$$

$$\tan(\phi_v - \phi_{v-1}) = \sqrt{1 - k_{v-1}^2} \tan \phi_{v-1}. \quad (i)$$

It is further evident that $F(k_n, \phi_n)$ approaches the limit $\int_0^\Phi d\phi = \Phi$, where Φ is the limiting value of ϕ as n increases.

If $\phi = \frac{\pi}{2}$, it follows at once from (i), see also Art. 49, that

$$\phi_1 = \pi, \phi_2 = 2\pi, \dots, \phi_n = 2^{n-1}\pi,$$

and consequently

$$K = F\left(k, \frac{\pi}{2}\right) = \frac{\pi}{2}(1+k_1)(1+k_2)(1+k_3)\dots$$

Art. 44. Suppose, for example, that it is required to find $F(\frac{1}{2}, 40^\circ)$. Using the seven-place logarithm tables of Vega, it is found that for

$$\phi = 40, \sin \theta = k = \frac{1}{2}, \text{ or } \theta = 30,$$

$\sqrt{1 - k^2} = k' = 0.86603$	
$1 - k' = 0.13397$	$\log(1 - k') = 9.1270076$
$1 + k' = 1.86603$	$\text{colog}(1 + k') = 9.7290814$
$k_1 = 0.071794$	$\log k_1 = 8.8560890$
$1 - k_1 = 0.928206$	$\log(1 - k_1) = 9.9676444$
$1 + k_1 = 1.071794$	$\log(1 + k_1) = 0.0301098$
	$\log k_1^2 = 9.9977542$
$k'_1 = 0.997418$	$\log k'_1 = 9.9988771$
$1 - k'_1 = 0.002582$	$\log(1 - k'_1) = 7.4121244$
$1 + k'_1 = 1.997418$	$\text{colog}(1 + k'_1) = 9.6995263$
	$\log k_2 = 7.1116507$
$k_2 = 0.001293$	

$$\begin{array}{ll} 1 - k_2 = 0.998707 & \log(1 - k_2) = 9.9994381 \\ 1 + k_2 = 1.001293 & \log(1 + k_2) = 0.0005599 \end{array}$$

$$\log k'^2 = 9.9999980$$

$$k'_2 = 1 \quad \log k'_2 = 9.9999990$$

$$k_3 = 0$$

$$\log k' = 9.9375329$$

$$\log \tan \phi = 9.9238135$$

$$\log \tan(\phi_1 - \phi) = 9.8613464$$

$$\phi_1 - \phi = 36^\circ \quad \begin{array}{l} \text{o}' \\ \text{20}'' \end{array}$$

$$\phi_1 = 76^\circ \quad \begin{array}{l} \text{o}' \\ \text{20}'' \end{array}$$

$$\log k'_1 = 9.9988771$$

$$\log \tan \phi_1 = 0.6034084$$

$$\log \tan(\phi_2 - \phi_1) = 0.6022855$$

$$\phi_2 - \phi_1 = 75^\circ \quad \begin{array}{l} 58' \\ 15'' \end{array}$$

$$\phi_2 = 151^\circ \quad \begin{array}{l} 58' \\ 35'' \end{array}$$

$$\tan(\phi_3 - \phi_2) = \tan \phi_2$$

$$\Phi = \phi_3 = 2\phi_2 = 303^\circ \quad \begin{array}{l} 57' \\ 10'' \end{array}$$

$$\frac{1}{2^3}\Phi = 37^\circ \quad \begin{array}{l} 59' \\ 39'' \end{array}$$

$$= 136779''$$

$$\pi = 648000''$$

$$\log\left(\frac{1}{2^3}\Phi\right)'' = 5.1360194$$

$$\text{colog } \pi'' = 4.1884250$$

$$\log \pi = 0.4971499$$

$$\log\left(\frac{1}{2^3}\Phi\right) = 9.8215943$$

$$\log(1 + k_1) = 0.0301098$$

$$\log(1 + k_2) = 0.0005599$$

$$\log\left(\frac{1}{2^3}\Phi\right) = 9.8215943$$

$$\log F\left(\frac{1}{2}, 40^\circ\right) = 9.8522640$$

$$F\left(\frac{1}{2}, 40^\circ\right) = .711646$$

The value given in Legendre's tables is

$$.7116472757$$

Art. 45. The formulas of Art. 42 may be used to increase the modulus and decrease the amplitude; for if the subscripts be interchanged, it is seen that

$$F(k, \phi) = \frac{2}{1+k} F(k_1, \phi_1), \quad (i)$$

$$k_1 = \frac{2\sqrt{k}}{1+k},$$

$$\sin(2\phi_1 - \phi) = k \sin \phi,$$

where $k_1 > k$ and $\phi_1 < \phi$.

Applying the formula (i) n times, there results

$$F(k, \phi) = \frac{2}{1+k} \cdot \frac{2}{1+k_1} \cdot \dots \cdot \frac{2}{1+k_{n-1}} F(k_n, \phi_n);$$

or, since

$$\frac{2}{1+k} = \frac{k_1}{\sqrt{k}}, \quad \frac{2}{1+k_1} = \frac{k_2}{\sqrt{k_1}}, \text{ etc.},$$

it is seen that

$$F(k, \phi) = k_n \sqrt{\frac{k_1 k_2 \dots k_{n-1}}{k}} F(k_n, \phi_n),$$

where

$$k_i = \frac{2\sqrt{k_{v-1}}}{1+k_{v-1}}, \quad \sin(2\phi_v - \phi_{v-1}) = k_{v-1} \sin \phi_{v-1} (v = 1, 2, \dots; k_0 = k, \phi_0 = \phi).$$

It follows also that

$$F(k_n, \phi_n) = F(1, \Phi) = \int_0^\Phi \frac{d\phi}{\sqrt{1 - \sin^2 \phi}} = \int_0^\Phi \sec \phi d\phi = \log_e \tan\left(\frac{\pi}{4} + \frac{\Phi}{2}\right)$$

and

$$F(k, \phi) = \sqrt{\frac{k_1 k_2 \dots k_{n-1}}{k}} \log_e \tan\left(\frac{\pi + \Phi}{4} + \frac{\phi}{2}\right).$$

Art. 46. The method of the preceding articles may also be used to evaluate $F(30^\circ, 40^\circ)$, thus

$$\begin{array}{ll} k = .5 & \log k = 9.6989700 \\ 1+k = 1.5 & \log(1+k) = 0.1760913 \end{array}$$

$$\begin{array}{l} \log \sqrt{k} = 9.8494850 \\ \log 2 = 0.3010300 \\ \text{colog}(1+k) = 9.8239087 \\ \hline \end{array}$$

$$\log k_1 = 9.9744237$$

$$\begin{array}{ll} k_1 = .942809 & \log k_1 = 9.9744237 \\ 1+k_1 = 1.942809 & \log(1+k_1) = 0.2884301 \end{array}$$

$$\begin{array}{l} \log \sqrt{k_1} = 9.9872118 \\ \log 2 = 0.3010300 \\ \text{colog}(1+k_1) = 9.7115699 \\ \hline \end{array}$$

$$\log k_2 = 9.9998117$$

$$\begin{array}{ll} k_2 = .999567 & \log k_2 = 9.9998117 \\ 1+k_2 = 1.999567 & \log(1+k_2) = 0.3009359 \end{array}$$

$$\begin{array}{l} \log \sqrt{k_2} = 9.9999059 \\ \log 2 = 0.3010300 \\ \text{colog}(1+k_2) = 9.6990641 \\ \hline \end{array}$$

$$\log k_3 = 0.0000000$$

$$k_3 = 1.$$

$$\begin{array}{l} \log k = 9.6989700 \\ \log \sin \phi = 9.8080675 \\ \hline \end{array}$$

$$\log \sin(2\phi_1 - \phi) = 9.5070375$$

$$\begin{array}{lll} 2\phi_1 - \phi = 18^\circ & 44' & 50.''05 \\ 2\phi_1 = 58^\circ & 44' & 50.''10 \\ \phi_1 = 29^\circ & 22' & 25.''05 \end{array}$$

$$\begin{aligned}
 & \log k_1 = 9.99744237 \\
 & \log \sin \phi_1 = 9.6906403 \\
 \hline
 & \log \sin (2\phi_2 - \phi_1) = 9.6650640 \\
 & \quad 2\phi_2 - \phi_1 = 27^\circ \quad 32' \quad 43.''08 \\
 & \quad \quad 2\phi_2 = 56^\circ \quad 54' \quad 68.''13 \\
 & \quad \quad \quad \phi_2 = 28^\circ \quad 27' \quad 34.''06 \\
 & \log k_2 = 9.9998117 \\
 & \log \sin \phi_2 = 9.6780866 \\
 \hline
 & \log \sin (2\phi_3 - \phi_2) = 9.6778983 \\
 & \quad 2\phi_3 - \phi_2 = 28^\circ \quad 26' \quad 45.''53 \\
 & \quad \quad 2\phi_3 = 56^\circ \quad 54' \quad 19.''59 \\
 & \quad \quad \quad \phi_3 = 28^\circ \quad 27' \quad 9.''78
 \end{aligned}$$

When $k_3 = 1$, then $\sin (2\phi_4 - \phi_3) = \sin \phi_3$, or $\phi_4 = \phi_3$.

$$\begin{aligned}
 \therefore \phi_4 &= 28^\circ \quad 27' \quad 9.''78 \\
 \frac{\phi_4}{2} &= 14^\circ \quad 13' \quad 34.''89 \\
 \Phi = \frac{\phi_4}{2} + \frac{\pi}{4} &= 59^\circ \quad 13' \quad 34.''89 \\
 \Phi &= 59^\circ \quad 13' \quad 34.''89 \\
 \log_{10} \tan \Phi &= .2251208 \\
 \log \log \tan \Phi &= 9.3524156 \\
 \operatorname{colog} M &= 0.3622157 \quad (*\text{see below}) \\
 \log \sqrt{k_1} &= 9.9872118 \\
 \log \sqrt{k_2} &= 9.9999059 \\
 \operatorname{colog} \sqrt{k} &= 0.1505150 \\
 \hline
 \log F(30^\circ, 40^\circ) &= 9.8522640 \\
 F(30^\circ, 40^\circ) &= .711647. \dots
 \end{aligned}$$

Art. 47. Cayley, *Elliptic Functions*, p. 324, introduced instead of the standard form of the radical, a new form

$$\sqrt{a^2 \cos^2 \phi + b^2 \sin^2 \phi} \quad (a > b);$$

* Division is made by the modulus M to change from the natural to the common logarithm, where $M = .43429448$.

and he further wrote

$$F(a, b, \phi) = \int_0^\phi \frac{d\phi}{\sqrt{a^2 \cos^2 \phi + b^2 \sin^2 \phi}}, \dots \quad (1)$$

$$E(a, b, \phi) = \int_0^\phi \sqrt{a^2 \cos^2 \phi + b^2 \sin^2 \phi}. \dots \quad (2)$$

It is clear that

$$\sqrt{a^2 \cos^2 \phi + b^2 \sin^2 \phi} = a \sqrt{1 - k^2 \sin^2 \phi},$$

where

$$k^2 = 1 - \frac{b^2}{a^2}, \quad k' = \frac{b}{a}.$$

The functions (1) and (2) are consequently $\frac{1}{a}F(k, \phi)$ and $aE(k, \phi)$.

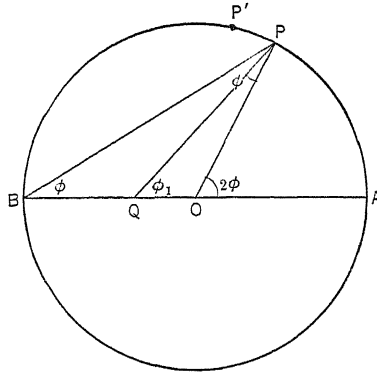

FIG. 17.

In the figure let P be a point on the circle, whose centre is O and let Q be any point on the diameter AB .

Further let

$$QA = a, \quad QB = b, \quad \angle AQP = \phi_1, \quad \angle AOP = 2\phi, \quad \angle ABP = \phi.$$

$$\text{Write } a_1 = \frac{1}{2}(a+b), \quad b_1 = \sqrt{ab}, \quad c_1 = \frac{1}{2}(a-b).$$

It follows at once that

$$OA = OB = OP = a_1, \quad OQ = a_1 - b = \frac{1}{2}(a-b) = c_1,$$

$$QP \sin \phi_1 = a_1 \sin 2\phi,$$

$$QP \cos \phi_1 = c_1 + a_1 \cos 2\phi.$$

On the other hand

$$\begin{aligned} \overline{QP}^2 &= c_1^2 + 2c_1a_1 \cos 2\phi + a_1^2 = \frac{1}{2}(a^2 + b^2) + \frac{1}{2}(a^2 - b^2) \cos 2\phi \\ &= \frac{1}{2}(a^2 + b^2)(\cos^2 \phi + \sin^2 \phi) + \frac{1}{2}(a^2 - b^2)(\cos^2 \phi - \sin^2 \phi) \\ &= a^2 \cos^2 \phi + b^2 \sin^2 \phi. \end{aligned}$$

Therefore it follows that

$$\sin \phi_1 = \frac{a_1 \sin 2\phi}{\sqrt{a^2 \cos^2 \phi + b^2 \sin^2 \phi}}, \quad \cos \phi_1 = \frac{c_1 + a_1 \cos 2\phi}{\sqrt{a^2 \cos^2 \phi + b^2 \sin^2 \phi}};$$

and consequently

$$a_1^2 \cos^2 \phi_1 + b_1^2 \sin^2 \phi_1 = \frac{a_1^2(a \cos^2 \phi + b \sin^2 \phi)^2}{a^2 \cos^2 \phi + b^2 \sin^2 \phi}. \quad (I)$$

It is seen at once that

$$\begin{aligned} \sin (2\phi - \phi_1) &= \frac{\frac{1}{2}(a-b) \sin 2\phi}{\sqrt{a^2 \cos^2 \phi + b^2 \sin^2 \phi}}, \\ \cos (2\phi - \phi_1) &= \frac{a \cos^2 \phi + b \sin^2 \phi}{\sqrt{a^2 \cos^2 \phi + b^2 \sin^2 \phi}}; \text{ or, from (I),} \\ \cos (2\phi - \phi_1) &= \frac{I}{a_1} \sqrt{a_1^2 \cos^2 \phi_1 + b_1^2 \sin^2 \phi_1}. \end{aligned}$$

If in the figure we consider the point P' consecutive to P , then, $PQ d\phi_1 = PP' \sin PP'Q = 2a_1 \cos (2\phi - \phi_1) d\phi$;

or, writing for PQ its value from above, there results

$$\frac{2d\phi}{\sqrt{a^2 \cos^2 \phi + b^2 \sin^2 \phi}} = \frac{d\phi_1}{\sqrt{a_1^2 \cos^2 \phi_1 + b_1^2 \sin^2 \phi_1}}.$$

Integrating, this expression becomes

$$F(a, b, \phi) = \frac{1}{2}F(a_1, b_1, \phi_1),$$

or

$$F(k, \phi) = \frac{I}{2} \frac{a}{a_1} F(k', \phi') = \frac{I}{I+k'} F(k_1, \phi_1),$$

where

$$\sin \phi_1 = \frac{\frac{1}{2}(1+k') \sin 2\phi}{\sqrt{1-k^2 \sin^2 \phi}}.$$

$$\text{Note that } k^2 = 1 - \frac{b^2}{a^2}, k' = \frac{b}{a}; k_1^2 = 1 - \frac{b_1^2}{a_1^2} = \left(\frac{a-b}{a+b}\right)^2 = \left(\frac{1-k'}{1+k'}\right)^2;$$

or, $k_1 = \frac{1-k'}{1+k'}$, and $k' = \frac{1-k_1}{1+k_1}$, as given at the end of Art. 42.

Art. 48. Cayley derives a similar formula for the integrals of the second kind as follows, his work being here in places considerably simplified. From the relation of Art. 42, we have

$$\sin (2\phi - \phi_1) = k_1 \sin \phi_1, \text{ or}$$

$$\sin 2\phi \cos \phi_1 - \cos 2\phi \sin \phi_1 = k_1 \sin \phi_1;$$

it follows that

$$\cos 2\phi = -k_1 \sin^2 \phi_1 + \cos \phi_1 \Delta \phi_1,$$

and consequently

$$2 \cos^2 \phi = 1 - k_1 \sin^2 \phi_1 + \cos \phi_1 \Delta \phi_1,$$

$$2 \sin^2 \phi = 1 + k_1 \sin^2 \phi_1 - \cos \phi_1 \Delta \phi_1.$$

From these two relations it is seen at once that

$$\begin{aligned} 2 (a^2 \cos^2 \phi + b^2 \sin^2 \phi) &= a^2 + b^2 - (a^2 - b^2) k_1 \sin^2 \phi_1 \\ &+ (a^2 - b^2) \cos \phi_1 \Delta \phi_1 = (a^2 + b^2) (\cos^2 \phi_1 + \sin^2 \phi_1) \\ &- (a^2 - b^2) k_1 \sin^2 \phi_1 + (a^2 - b^2) \cos \phi_1 \Delta \phi_1 \\ &= 4(a_1^2 \cos^2 \phi_1 + b_1^2 \sin^2 \phi_1) \\ &- 2b_1^2 + 4c_1 \cos \phi_1 \sqrt{a_1^2 \cos^2 \phi_1 + b_1^2 \sin^2 \phi_1}. \end{aligned}$$

Multiply this expression by the differential relation given above, viz.,

$$\frac{2d\phi}{\sqrt{a^2 \cos^2 \phi + b^2 \sin^2 \phi}} = \frac{d\phi_1}{\sqrt{a_1^2 \cos^2 \phi_1 + b_1^2 \sin^2 \phi_1}},$$

and integrating, there results

$$E(a, b, \phi) = E(a_1, b_1, \phi_1) - \frac{1}{2} b_1^2 F(a_1, b_1, \phi_1) + c_1 \sin \phi_1,$$

where

$$\sin \phi_1 = \frac{a_1 \sin 2\phi}{\sqrt{a^2 \cos^2 \phi + b^2 \sin^2 \phi}}.$$

It follows at once that

$$E(k, \phi) = \frac{a_1}{a} E(k_1, \phi_1) - \frac{1}{2} \frac{b_1^2}{aa_1} F(k_1, \phi_1) + \frac{c_1}{a} \sin \phi_1,$$

or

$$E(k, \phi) = \frac{1}{2}(1+k')E(k_1, \phi_1) - \frac{k'}{1+k'}F(k_1, \phi_1) + \frac{1}{2}(1-k')\sin \phi_1,$$

with the initial relation

$$\sin (2\phi - \phi_1) = k_1 \sin \phi_1.$$

Art. 49. From the formula connecting ϕ and ϕ_1 , which may be written in the form (see end of Art. 42)

$$\tan \phi_1 = \frac{(1+k') \tan \phi}{1-k' \tan^2 \phi}, \quad \dots \dots \dots (I)$$

it is seen that ϕ and ϕ_1 vanish at the same time; and further since

$$\frac{d\phi'}{d\phi} = (1+k') \frac{1+k' \tan^2 \phi}{(1-k' \tan^2 \phi)^2} \frac{\cos^2 \phi_1}{\cos^2 \phi},$$

a positive quantity, it appears that ϕ_1 increases with ϕ . It is further evident that $\tan \phi_1 = 0$ when $\tan \phi = \infty$. It is clear from

(I) that when $\phi = 0$, $\phi_1 = 0$ and when $\tan \phi = \sqrt{\frac{1}{k'}} = \sqrt{\frac{a}{b}}$, then

$\phi_1 = \frac{1}{2}\pi$; and in general to the values $\frac{\pi}{2}, \pi, 2\pi, \dots$ of ϕ , there correspond the values $\pi, 2\pi, 4\pi, \dots$ of ϕ_1 .

Art. 50. Denote the complete functions $F\left(a, b, \frac{\pi}{2}\right), E\left(a, b, \frac{\pi}{2}\right)$

by $F(a, b)$, $E(a, b)$, then

$$F(a, b) = \frac{1}{2}F(a_1, b_1, \pi) = F\left(a_1, b_1, \frac{\pi}{2}\right) = F(a_1, b_1);$$

and similarly

$$E(a, b) = 2E(a_1, b_1) - b_1^2F(a_1, b_1).$$

Art. 51. *Continued repetition of the above transformations.* In the same manner as a_1, b_1, c_1 were derived from a, b , we may derive a_2, b_2, c_2 from a_1, b_1 , etc., and thus form the following table:

$$\begin{array}{lll} a_1 = \frac{1}{2}(a+b), & b_1 = \sqrt{ab}, & c_1 = \frac{1}{2}(a-b), \\ a_2 = \frac{1}{2}(a_1+b_1), & b_2 = \sqrt{a_1b_1}, & c_2 = \frac{1}{2}(a_1-b_1), \\ a_3 = \frac{1}{2}(a_2+b_2), & b_3 = \sqrt{a_2b_2}, & c_3 = \frac{1}{2}(a_2-b_2), \\ \cdot & \cdot & \cdot \end{array}$$

Note that $a_1 - b_1 = \frac{(\sqrt{a} - \sqrt{b})^2}{2}$ and that

$$a_2 - b_2 = \frac{a_1 + b_1}{2} - \sqrt{a_1b_1} = \frac{a_1 - b_1}{2} - [\sqrt{a_1} - \sqrt{b_1}]\sqrt{b_1},$$

so that

$$a_2 - b_2 < \frac{a_1 - b_1}{2} \text{ or } a_2 - b_2 < \frac{(\sqrt{a} - \sqrt{b})^2}{2^2}.$$

Similarly it is seen that $a_3 - b_3 < \frac{a_2 - b_2}{2} < \frac{(\sqrt{a} - \sqrt{b})^3}{2^3}$; and in

general $a_n - b_n < \frac{(\sqrt{a} - \sqrt{b})^n}{2^n}$, or $\lim (a_n - b_n) = 0$. It is clear that as n increases a_n and b_n approach (very rapidly) one and the same limit, which is called* by Gauss the *arithmetico-geometrical mean* and denoted by him with the symbol $M(a, b) = \mu$. However, when $a_n = b_n$, then

$$F(a_n, b_n, \phi) = \frac{\phi}{a_n} \text{ and } E(a_n, b_n, \phi) = a_n \phi;$$

* Gauss, *Werke*, III, pp. 361-404.

further if $\phi = \frac{1}{2}\pi$, it is seen that

$$F(a_n, b_n) = \frac{\pi}{2a_n} \text{ and } E(a_n, b_n) = \frac{\pi}{2} a_n, \text{ where } a_n = \mu.$$

The equation $F(a, b, \phi) = \frac{1}{2} F(a_1, b_1, \phi_1)$ gives

$$\begin{aligned} F(a, b, \phi) &= \frac{1}{2} F(a_1, b_1, \phi_1) = \frac{1}{2^2} F(a_2, b_2, \phi_2) \\ &= \dots = \frac{1}{2^n} F(a_n, b_n, \phi_n) = \frac{1}{2^n a_n} \phi_n, \end{aligned}$$

where the ϕ 's are to be calculated from the formula

$$\begin{aligned} \sin \phi_1 &= \frac{a_1 \sin 2\phi}{\sqrt{a^2 \cos^2 \phi + b^2 \sin^2 \phi}}, \\ \sin \phi_2 &= \frac{a_2 \sin 2\phi_1}{\sqrt{a_1^2 \cos^2 \phi_1 + b_1^2 \sin^2 \phi_1}}, \dots \end{aligned}$$

Art. 52. *The integrals of the second kind.* Note that, since

$$F(a, b, \phi) = \frac{1}{2} F(a_1, b_1, \phi_1),$$

the formula above for the E -function may be written

$$\begin{aligned} E(a, b, \phi) - a^2 F(a, b, \phi) &= E(a_1, b_1, \phi_1) - a_1^2 F(a_1, b_1, \phi_1) \\ &\quad + F(a_1, b_1, \phi_1) (a_1^2 - \frac{1}{2} a^2 - \frac{1}{2} b_1^2) + c_1 \sin \phi_1; \\ \text{or, since } a_1^2 - \frac{1}{2} a^2 - \frac{1}{2} b_1^2 &= -\frac{1}{4} (a^2 - b^2) = -a_1 c_1, \end{aligned}$$

the above equation is

$$\begin{aligned} E(a, b, \phi) - a^2 F(a, b, \phi) &= E(a_1, b_1, \phi_1) - a_1^2 F(a_1, b_1, \phi_1) \\ &\quad - a_1 c_1 F(a_1, b_1, \phi_1) + c_1 \sin \phi_1. \end{aligned}$$

Observing that, as n increases,

$$\lim [E(a_n, b_n, \phi_n) - a_n^2 F(a_n, b_n, \phi_n)] = 0,$$

it is seen that

$$\begin{aligned} E(a, b, \phi) - a^2 F(a, b, \phi) &= -[2a_1 c_1 + 4a_2 c_2 + 8a_3 c_3 + \dots] F(a, b, \phi) \\ &\quad + c_1 \sin \phi_1 + c_2 \sin \phi_2 + c_3 \sin \phi_3 + \dots; \end{aligned}$$

or finally

$$\begin{aligned} E(a, b, \phi) &= [a^2 - 2a_1 c_1 - 4a_2 c_2 - 8a_3 c_3 - \dots] F(a, b, \phi) \\ &\quad + c_1 \sin \phi_1 + c_2 \sin \phi_2 + c_3 \sin \phi_3 + \dots \end{aligned}$$

In particular, if $\phi = \frac{1}{2}\pi$, we have Art. 49, $\phi_1 = \pi$, $\phi_2 = 2\pi, \dots$, and then

$$E(a, b) = [a^2 - 2a_1c_1 - 4a_2c_2 - \dots] \frac{\pi}{2a_n}.$$

It also follows immediately that

$$E(k, \phi) = \left[1 - \frac{2a_1c_1}{a^2} - \frac{4a_2c_2}{a^2} - \dots \right] F(k, \phi) \\ + \frac{c_1}{a} \sin \phi_1 + \frac{c_2}{a} \sin \phi_2 + \frac{c_3}{a} \sin \phi_3 + \dots ;$$

or, noting that

$$\frac{a_1c_1}{a_2} = \frac{1}{4}k^2, \quad \frac{a_2c_2}{a_1c_1} = \frac{1}{4}k_1, \quad \frac{a_3c_3}{a_2c_2} = \frac{1}{4}k_2, \dots, \\ \frac{c_1}{a} = \frac{k_1}{1+k_1}, \\ \frac{c_2}{a_1} = \frac{k_2}{1+k_2}, \quad \frac{a_1}{a} = \frac{1}{1+k_1}, \\ \frac{c_3}{a_2} = \frac{k_3}{1+k_3}, \quad \frac{a_2}{a_1} = \frac{1}{1+k_2}, \quad \frac{a_1}{a} = \frac{1}{1+k_1}, \dots,$$

the equation becomes,

$$E(k, \phi) = \left[1 - \frac{1}{2}k^2 \left(1 + \frac{1}{2}k_1 + \frac{1}{4}k_1k_2 + \frac{1}{8}k_1k_2k_3 + \dots \right) \right] F(k, \phi) \\ + \frac{k_1}{1+k_1} \sin \phi_1 + \frac{k_2}{(1+k_1)(1+k_2)} \sin \phi_2 \\ + \frac{k_3}{(1+k_1)(1+k_2)(1+k_3)} \sin \phi_3 + \dots$$

Further since

$$\frac{1}{1+k_1} = \frac{k}{2\sqrt{k_1}}, \quad \text{or} \quad \frac{1}{1+k_1} = \frac{k}{2\sqrt{k_1}}, \\ \frac{1}{1+k_2} = \frac{k_1}{2\sqrt{k_2}}, \quad \text{or} \quad \frac{1}{(1+k_1)(1+k_2)} = \frac{k\sqrt{k_1}}{4\sqrt{k_2}}, \\ \frac{1}{1+k_3} = \frac{k_2}{2\sqrt{k_3}}, \quad \text{or} \quad \frac{1}{(1+k_1)(1+k_2)(1+k_3)} = \frac{k\sqrt{k_1k_2}}{8\sqrt{k_3}}, \\ \dots \quad \dots \quad \dots \quad \dots \quad \dots \quad \dots \quad \dots$$

the last line of the above expression may be written

$$k[\frac{1}{2}\sqrt{k_1} \sin \phi_1 + \frac{1}{4}\sqrt{k_1 k_2} \sin \phi_2 + \frac{1}{8}\sqrt{k_1 k_2 k_3} \sin \phi_3 + \dots]$$

In particular if $\phi = \frac{1}{2}\pi$, we have

$$E_1 = E\left(k, \frac{\pi}{2}\right) = [1 - \frac{1}{2}k^2(1 + \frac{1}{2}k_1 + \frac{1}{4}k_1 k_2 + \frac{1}{8}k_1 k_2 k_3 + \dots)]F_1(k).$$

Art. 53. As a numerical example (see Legendre, *Traité* etc., T. I, p. 91), let $a = 1$, $b = \frac{1}{2}\sqrt{2 - \sqrt{3}} = \cos 75^\circ$, and let $\tan \phi = \sqrt{\frac{2}{\sqrt{3}}}$.

It follows that $k^2 = 1 - \frac{b^2}{a^2} = \sin 75^\circ$.

The following table may be at once constructed.

Index	a	b	c	k	k'	ϕ
						o ' "
(o)	1.0000000	0.2588190	0.9659258	0.2588190	47 3 31
(1)	0.6294095	0.5087426	0.3705905	0.5887908	0.8082856	62 36 3
(2)	0.5690761	0.5658688	0.0603334	0.1060200	0.9943636	119 55 48
(3)	0.5674724	0.5674701	0.0016037	0.0028260	0.9999959	240 0 0
(4)	0.5674713	0.5674713	0.000011	0.0000020	0.9999999	480 0 0

(See Cayley, loc. cit., p. 335.)

The complete integral $F_1 = \frac{\pi}{2} \frac{1}{a_4} = 2.768063 \dots$ and

$$F(75^\circ, 47^\circ 3' 31'') = \frac{\phi_4}{8} \cdot \frac{1}{a_4} = 0.9226877 \dots$$

Note that the first integral is *three times* the second. It is also seen that

$$\begin{aligned} \frac{1}{2}\left(1 - \frac{E_1}{F_1}\right) &= a_1 c_1 = .2332532 \\ &+ 2a_2 c_2 = .0686686 \\ &+ 4a_3 c_3 = .0036402 \\ &+ 8a_4 c_4 = .0000051 \\ &= .3055671 \end{aligned}$$

and $E_1 = 1.0764051 \dots$

The computation of $E(k, \phi)$ is found in the next article.

Art. 54. To establish in a somewhat different manner the results that were given in the preceding article, consider * a function $G(k, \phi)$ composed of an integral of the first and of an integral of the second kind, such that

$$G(k, \phi) = \int_0^{\phi} \frac{\alpha + \beta \sin^2 \phi}{\sqrt{1 - k^2 \sin^2 \phi}} d\phi,$$

where α and β are constants.

Making in this integral the substitutions of Arts. 42 and 48, namely

$$\frac{d\phi}{\Delta\phi} = \frac{1+k_1}{2} \frac{d\phi_1}{\Delta\phi_1}, \quad \sin^2 \phi = \frac{1}{2}(1+k_1 \sin^2 \phi_1 - \Delta\phi_1 \cos \phi_1),$$

it is seen that

$$G(k, \phi) = \frac{1+k_1}{2} [G(k_1, \phi_1) - \frac{1}{2}\beta \sin \phi_1], \quad \dots \quad (1)$$

where

$$G(k_1, \phi_1) = \int_0^{\phi_1} \frac{\alpha_1 + \beta_1 \sin^2 \phi_1}{\Delta\phi_1} d\phi_1,$$

the constants α_1 and β_1 being defined by the relations

$$\alpha_1 = \alpha + \frac{1}{2}\beta, \quad \beta_1 = \frac{1}{2}\beta k_1.$$

We saw in Art. 48 that

$$k_1 = \frac{1 - \sqrt{1 - k^2}}{1 + \sqrt{1 - k^2}}, \quad \tan(\phi_1 - \phi) = \sqrt{1 - k^2} \tan \phi,$$

where $k_1 < k$ and $\phi_1 > \phi$.

It follows directly from (1) that

$$\begin{aligned} G(k, \phi) = & \frac{1+k_1}{2} \cdot \frac{1+k_2}{2} \dots \frac{1+k_n}{2} G(k_n, \phi_n) \\ & - \frac{1}{2} \left[\frac{1+k_1}{2} \beta \sin \phi_1 + \frac{1+k_1}{2} \cdot \frac{1+k_2}{2} \beta_1 \sin \phi_2 + \dots \right. \\ & \left. + \frac{1+k_1}{2} \cdot \frac{1+k_2}{2} \dots \frac{1+k_n}{2} \beta_{n-1} \sin \phi_n \right], \end{aligned}$$

* See also Legendre, *Traité*, etc., I, p. 108.

where

$$\beta_p = \beta \frac{k_1 k_2 \dots k_p}{2^p},$$

and

$$\alpha_p = \alpha + \frac{1}{2} \beta \left(1 + \frac{k_1}{2} + \frac{k_1 k_2}{2^2} + \dots + \frac{k_1 k_2 \dots k_{p-1}}{2^{p-1}} \right).$$

Since β_n becomes 0 with k_n , it is seen that

$$\lim_{n \rightarrow \infty} G(k_n, \phi_n) = \int_0^{\phi_n} \alpha_n d\phi = \alpha_n \phi_n.$$

From Art. 43 we had

$$\frac{1+k_1}{2} \cdot \frac{1+k_2}{2} \dots \frac{1+k_n}{2} \phi_n = F(k, \phi),$$

and, see Art. 42,

$$\frac{1+k_1}{2} = \frac{\sqrt{k_1}}{k}, \quad \frac{1+k_2}{2} = \frac{\sqrt{k_2}}{k_1}, \dots$$

It follows that the above formula becomes

$$G(k, \phi) = F(k, \phi) \left[\alpha + \frac{1}{2} \beta \left(1 + \frac{k_1}{2} + \frac{k_1 k_2}{2^2} + \frac{k_1 k_2 k_3}{2^3} + \dots \right) \right] - \frac{\beta}{k} \left(\frac{\sqrt{k_1}}{2} \sin \phi_1 + \frac{\sqrt{k_1 k_2}}{2^2} \sin \phi_2 + \frac{\sqrt{k_1 k_2 k_3}}{2^3} \sin \phi_3 + \dots \right).$$

If in this formula we put $\alpha = 1, \beta = -k^2$, it becomes

$$E(k, \phi) = F(k, \phi) \left[1 - \frac{k^2}{2} \left(1 + \frac{k_1}{2} + \frac{k_1 k_2}{2^2} + \frac{k_1 k_2 k_3}{2^3} + \dots \right) \right] + k \left[\frac{\sqrt{k_1}}{2} \sin \phi_1 + \frac{\sqrt{k_1 k_2}}{2^2} \sin \phi_2 + \frac{\sqrt{k_1 k_2 k_3}}{2^3} \sin \phi_3 + \dots \right],$$

where

$$k_p = \frac{1 - \sqrt{1 - k^2_{p-1}}}{1 + \sqrt{1 - k^2_{p-1}}}$$

and $\tan(\phi_p - \phi_{p-1}) = \sqrt{1 - k^2_{p-1}} \tan \phi_{p-1}.$

These results verify those of Art. 52.

With Legendre, *Fonct. Ellip.*, T. I., p. 114, we may find

$$E(k, \phi) \text{ where } k = \sin 75^\circ \text{ and } \tan \phi = \sqrt{\frac{2}{\sqrt{3}}}.$$

Using the results of Art. 53 it is seen that

$$\frac{k\sqrt{k_1}}{2} \sin \phi_1 = .3290186$$

$$\frac{k\sqrt{k_1 k_2}}{4} \sin \phi_2 = .0522872$$

$$\frac{k\sqrt{k_1 k_2 k_3}}{8} \sin \phi_3 = -.0013888$$

$$\frac{k\sqrt{k_1 k_2 k_3 k_4}}{16} \sin \phi_4 = .0000010$$

$$\text{sum} = \overline{.3799180}$$

Writing

$$L = 1 - \frac{k^2}{2} - \frac{k^2 k_1}{4} - \frac{k^2 k_1 k_2}{8} - \frac{k^2 k_1 k_2 k_3}{16},$$

it is found that $L = .3888658 \dots$

In Art. 53 it was seen that $F(k, \phi) = .9226877 \dots$

It follows that $E(k, \phi) = F(k, \phi)L + .3799180 \dots$
 $.07387196 \dots$

Further since

$$E\left(k, \frac{\pi}{2}\right) = F\left(k, \frac{\pi}{2}\right)L,$$

there follows

$$E_1 = 1.0764049 \dots$$

Art. 55. Inverse order of transformation. If the modulus k is nearer unity than zero, the following method is preferable. The equation (1) of the preceding article may be written

$$G(k_1, \phi_1) = \frac{2}{1+k_1} G(k, \phi) + \frac{\beta_1}{k_1} \sin \phi_1, \text{ since } \frac{\beta_1}{k_1} = \frac{\beta}{2}.$$

If in this formula the suffixes be interchanged, then

$$G(k, \phi) = \frac{2}{1+k} G(k_1, \phi_1) + \frac{\beta}{k} \sin \phi,$$

where now

$$\beta_1 = \frac{2\beta}{k}, \quad \alpha_1 = \alpha - \frac{\beta}{k},$$

$$k_1 = \frac{2\sqrt{k}}{1+k}, \quad \sin(2\phi_1 - \phi) = k \sin \phi,$$

$$k_1 > k, \quad \phi_1 < \phi.$$

The continued repetition of (2) gives

$$\begin{aligned} G(k, \phi) &= \frac{\beta}{k} \sin \phi + \frac{\beta_1}{\sqrt{k}} \sin \phi_1 + \frac{\sqrt{k_1}}{\sqrt{k}} \beta_2 \sin \phi_2 \\ &+ \frac{\sqrt{k_1 k_2}}{\sqrt{k}} \beta_3 \sin \phi_3 + \frac{\sqrt{k_1 k_2 \dots k_{n-2}}}{\sqrt{k}} \beta_{n-1} \sin \phi_{n-1} \\ &+ k_n \frac{\sqrt{k_1 k_2 \dots k_{n-1}}}{\sqrt{k}} G(k_n, \phi_n), \end{aligned}$$

where

$$\beta_p = \frac{2^p \beta}{k k_1 \dots k_{p-1}},$$

and

$$\alpha_p = \alpha - \frac{\beta}{k} \left(1 + \frac{2}{k_1} + \frac{2^2}{k_1 k_2} + \dots + \frac{2^{p-1}}{k_1 k_2 \dots k_{p-1}} \right).$$

Since k_n approaches unity (rapidly) as n increases,

$$\begin{aligned} \lim G(k_n, \phi_n) &= \int_0^{\phi_n} \frac{\alpha_n + \beta_n \sin^2 \phi}{\cos \phi} d\phi \\ &= (\alpha_n + \beta_n) \log_e \tan \left(\frac{\pi}{4} + \frac{\phi_n}{2} \right) - \beta_n \sin \phi_n. \end{aligned}$$

In Art. 45 it was shown that

$$\lim k_n \sqrt{\frac{k_1 k_2 \dots k_{n-1}}{k}} \log \tan \left(\frac{\pi}{4} + \frac{\phi_n}{2} \right) = F(k, \phi).$$

We may consequently write the above formula

$$G(k, \phi) = F(k, \phi) \left[\alpha - \frac{\beta}{k} \left(1 + \frac{2}{k_1} + \frac{2^2}{k_1 k_2} + \dots + \frac{2^{n-1} - 2^n}{k_1 k_2 \dots k_{n-1}} \right) \right] \\ + \frac{\beta}{k} \left[\sin \phi + \frac{2}{\sqrt{k}} \sin \phi_1 + \frac{2^2}{\sqrt{k k_1}} \sin \phi_2 + \frac{2^3}{\sqrt{k k_1 k_2}} \sin \phi_3 + \dots \right. \\ \left. + \frac{2^{n-1}}{\sqrt{k k_1 \dots k_{n-2}}} \sin \phi_{n-1} - \frac{2^n}{\sqrt{k k_1 \dots k_{n-1}}} \sin \phi_n \right].$$

Writing $\alpha = 1, \beta = -k^2$ in this formula, it becomes

$$E(k, \phi) = F(k, \phi) \left[1 + k \left(1 + \frac{2}{k_1} + \frac{2^2}{k_1 k_2} + \dots \right. \right. \\ \left. \left. + \frac{2^{n-1}}{k_1 k_2 \dots k_{n-1}} - \frac{2^n}{k_1 k_2 \dots k_{n-1}} \right) \right] \\ - k \left(\sin \phi + \frac{2}{\sqrt{k}} \sin \phi_1 + \frac{2^2}{\sqrt{k k_1}} \sin \phi_2 + \dots \right. \\ \left. + \frac{2^{n-1}}{\sqrt{k k_1 k_2 \dots k_{n-2}}} \sin \phi_{n-1} - \frac{2^n}{\sqrt{k k_1 \dots k_{n-1}}} \sin \phi_n \right),$$

where

$$k_p = \frac{2\sqrt{k_{p-1}}}{1+k_{p-1}} \text{ and } \sin(2\phi_p - \phi_{p-1}) = k_{p-1} \sin \phi_{p-1}.$$

Taking the example of the preceding article, and using the values given in Art. 53, it is seen that

$$-k \sin \phi = -0.7071070 \\ -2\sqrt{k} \sin \phi_1 = -1.4146540 \\ +4 \frac{\sqrt{k}}{\sqrt{k_1}} \sin \phi_2 = 2.8293085$$

$$F(k, \phi) = .9226877$$

and

$$F(k, \phi) \left[1 + k - \frac{2k}{k_1} \right] = \frac{0.0311720}{\dots} \\ E(k, \phi) = 0.7387195 \dots$$

Art. 56. Two of the principal problems that appear in practice will now be given.

PROBLEM 1. *When u and k are given, calculate the values of $sn u$, $cn u$, $dn u$.*

1. Computation of $sn u$. In the Table II, p. 96, is found an immediate answer to the problem.

For when u and $k = \sin \theta$ are known, the value ϕ may be found in the table and then $sn u$ from the formula $sn u = \sin \phi$.

If, for example, $k = \frac{1}{2} = \sin \theta$, and $u = .47551$, it is seen that for $\theta = 30^\circ$, $u = .47551$, we have $\phi = 27^\circ$, and $\sin \phi = .45399 = sn u$.

2. The computation of $cn u$ and $dn u$ are had from the formulas

$$cn u = \pm \sqrt{(1 - sn u)(1 + sn u)},$$

$$dn u = \pm \sqrt{(1 - ksn u)(1 + ksn u)}.$$

PROBLEM 2. *Having given the elliptic function, calculate the argument.*

1. If $sn u$ is known, find u . Table II furnishes the solution. Suppose that a is the given value of $sn u$, and suppose that $k = \sin \theta$ is also known. Hence, since $sn u = \sin \phi = a$, we may determine ϕ . With θ and ϕ known, we find the value of u from the table. Denote this value by u_0 . From the relation $sn u = sn u_0$, we have (Art. 21),

$$u = u_0 + 4mK + 2m'iK'.$$

Further in the formula (Art. 12).

$$sn u = -sn(u + 2K),$$

substitute $u = -u_0$, and then we have $-sn u_0 = -sn(2K - u_0)$, so that u may also have the form

$$u = 2K - u_0 + 4mK + 2m'iK'.$$

2. If $cn u$ and $dn u$ are given, $sn u$ and then u may be found as above.

CHAPTER V

MISCELLANEOUS EXAMPLES AND PROBLEMS

1. *The rectification of the lemniscate.* The equation of the curve is

$$(y^2 + x^2)^2 + a^2(y^2 - x^2) = 0;$$

or, writing $x = r \cos \theta$, $y = r \sin \theta$, the equation becomes

$$r^2 = a^2 \cos 2\theta.$$

From the expression $ds^2 = dr^2 + r^2 d\theta^2$, the differential of arc is

$$ds = \mp \frac{dr}{\sqrt{1 - \frac{r^4}{a^4}}} = \mp \frac{a d\theta}{\sqrt{1 - 2 \sin^2 \theta}}.$$

Writing, see II of Art. 3, $r = a \cos \phi$, so that $2 \sin^2 \theta = \sin \phi$, it is seen that

$$s = a \int_0^\theta \frac{d\theta}{\sqrt{1 - 2 \sin^2 \theta}} = \frac{a}{\sqrt{2}} \int_0^\phi \frac{d\phi}{\sqrt{1 - \frac{1}{2} \sin^2 \phi}} = \frac{a}{\sqrt{2}} F\left(\frac{1}{\sqrt{2}}, \phi\right),$$

which may be calculated at once from the tables when a and θ (or ϕ) are given. A quadrant of the lemniscate is

$$S_4 = a \int_0^{\frac{\pi}{4}} \frac{d\theta}{\sqrt{1 - 2 \sin^2 \theta}} = \frac{a}{\sqrt{2}} \int_0^{\frac{\pi}{2}} \frac{d\phi}{\sqrt{1 - \frac{1}{2} \sin^2 \phi}} = \frac{a}{\sqrt{2}} K\left(\frac{1}{\sqrt{2}}\right).$$

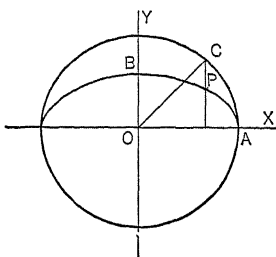

FIG. 18.

2. *The rectification of the ellipse.*

Let the equation be $\frac{x^2}{a^2} + \frac{y^2}{b^2} = 1$, $a > b$.

From the integral

$$s = \int_0^x \sqrt{1 + \left(\frac{dy}{dx}\right)^2} dx,$$

we have, by writing $k^2 = \frac{a^2 - b^2}{a^2}$, $x = a t$,

$$s = a \int_0^t \frac{(1 - k^2 t^2) dt}{\sqrt{(1 - t^2)(1 - k^2 t^2)}}.$$

Finally writing $t = \sin \phi$ (see Art. 3) and that is $x = a \sin \phi$, we have

$$s = \int_0^\phi \Delta \phi d\phi = aE(\phi).$$

Here k is the *numerical eccentricity* of the ellipse. The angle $\phi = COY = 90 - COA$, where in astronomy the angle COA is known as the eccentric anomaly of the point P . Writing $\phi = \pi/2$, it is seen that the quadrant of the ellipse is aE , where E is the *complete* integral of the second kind.

If the equation of the ellipse is taken in the form

$$x = a \sin \phi, \quad y = b \cos \phi,$$

it follows at once that

$$ds^2 = a^2(1 - k^2 \sin^2 \phi) d\phi^2, \quad \text{or} \quad s = aE(\phi).$$

3. The major and minor axes of an ellipse are 100 and 50 centimeters respectively. Find the length of the arc between the points (0, 25) and (48, 7). Find also the length of the arc between the points (48, 7) and (50, 0). Determine the length of its quadrant.

4. If λ denotes the latitude of a point P on the earth's surface, the equation of the ellipse through this point as indicated in the figure, may be written in the form

$$x = \frac{a \cos \lambda}{\sqrt{1 - e^2 \sin^2 \lambda}}, \quad y = \frac{a(1 - e^2) \sin \lambda}{\sqrt{1 - e^2 \sin^2 \lambda}}.$$

It follows at once that

$$ds^2 = dx^2 + dy^2 = \frac{a^2(1 - e^2)^2 d\lambda^2}{(1 - e^2 \sin^2 \lambda)^3}$$

so that

$$s = a(1 - e^2) \int_0^\lambda \frac{d\lambda}{(1 - e^2 \sin^2 \lambda)^{3/2}}.$$

This integral may be at once evaluated by the third formula in Art. 41.

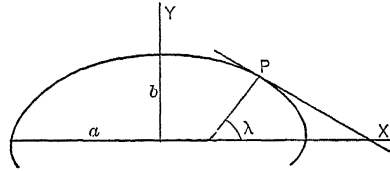

FIG. 19.

Compute the lengths of arc of the ellipse between 10° and 11° and between 79° and 80° where $a = 6378278$ meters and $e^2 = 0.0067686$. Compare these distances with the length of an arc that subtends 1° upon a circle with radius $= 6378278$ meters.

5. Plot the curves, the *elastic curves*, which are defined through the differential equation

$$d\phi = \pm \frac{y^2 dy}{\sqrt{a^4 - y^4}},$$

for the values $a = 1, 2, 4, 9$.

6. The axes of two right cylinders of radii a and b respectively ($a > b$) intersect at right angles. Find the volume common to both.

Let the z -axis be that of the larger cylinder and the y -axis that of the smaller, so that the equations of the cylinders are

$$x^2 + y^2 = a^2 \quad \text{and} \quad x^2 + z^2 = b^2 \quad \text{respectively.}$$

The volume in question is

$$V = 8 \int_0^b \sqrt{a^2 - x^2} \sqrt{b^2 - x^2} dx.$$

Writing $t = sn^{-1}\left(\frac{x}{b}, \frac{b}{a}\right)$, (see formula 5a, Art. 23), then $x = b sn t$, $b^2 - x^2 = b^2 cn^2 t$, $a^2 - x^2 = a^2 dn^2 t$, $d\phi = b cnt dn t dt$.

It follows that

$$V = 8ab^2 \int_0^K \left[1 - \frac{a^2 + b^2}{a^2} sn^2 t + \frac{b^2}{a^2} sn^4 t \right] dt. \quad (\text{See Byerly, } \textit{Int. Cal.}, 1902, \text{p. 276.})$$

Noting (see sixth formula of Art. 41, and (ii) of Art. 48) that

$$\int_0^K sn^2 t dt = \frac{1}{k^2} [K - E] \quad \text{and} \quad 3k^4 \int_0^K sn^4 t dt = 2K - 2E + k^2 K - 2k^2 E, \quad k^2 = \frac{b^2}{a^2},$$

it follows at once that

$$V = \frac{8}{3} a [(a^2 + b^2)E - (a^2 - b^2)K].$$

Compute V when $a = 60$ and $b = 12$ centimeters respectively; also find the volume common to both when the shortest distance between the axes is 8 centimeters.

7. The differential equation of motion of the simple pendulum is

$$\frac{d^2 s}{dt^2} = -g \frac{dy}{ds},$$

or multiplying by $\frac{2ds}{dt}$ and integrating,

$$\left(\frac{ds}{dt}\right)^2 = -2gy + C.$$

If the pendulum bob starts from the lowest point of its circular path with the initial velocity that would be acquired by a particle falling freely in a vacuum through the distance y_0 , so that $v_0^2 = 2gy_0$ (Byerly, loc. cit., p. 215), it is seen that this is the value of C , and consequently

$$\left(\frac{ds}{dt}\right)^2 = 2g(y_0 - y).$$

Further taking the starting-point as the origin (see figure) the equation of the circular path is $x^2 + y^2 - 2ay = 0$, so that

$$\left(\frac{ds}{dt}\right)^2 = \frac{a^2}{2ay - y^2} \left(\frac{dy}{dt}\right)^2,$$

and consequently

$$t = \frac{a}{\sqrt{2g}} \int_0^y \frac{dy}{\sqrt{(y_0 - y)(2ay - y^2)}},$$

which is the time required to reach that point of the path whose ordinate is y .

Writing $k^2 = \frac{y_0}{2a}$ and $\sin^2 \phi = \frac{y}{y_0}$, this integral becomes at once

$$t = \sqrt{\frac{a}{g}} \int_0^\phi \frac{d\phi}{\sqrt{1 - k^2 \sin^2 \phi}} = \sqrt{\frac{a}{g}} F(k, \phi).$$

Let $OC=CA=a$ be the length of the pendulum. Let A be the highest point reached by it in the oscillation so that the ordinate of A is y_0 . Let the angle ACO be α , and let θ be the angle PCO , where P is the point reached at the expiration of the time t .

It is seen that

$$\frac{y_0}{a} = 1 - \cos \alpha,$$

so that

$$\sqrt{\frac{y_0}{2a}} = \sqrt{\frac{1}{2}(1 - \cos \alpha)} = \sin \frac{\alpha}{2} = k;$$

and similarly,

$$\sqrt{\frac{y}{2a}} = \sin \frac{\theta}{2}.$$

It follows also that

$$\sin \phi = \sqrt{\frac{g}{y_0}} = \frac{\sin \frac{\theta}{2}}{\sin \frac{\alpha}{2}}.$$

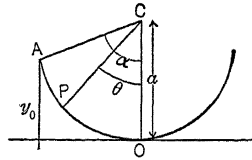

FIG. 20.

When $\theta = \alpha$, $\sin \phi = 1$, or $\phi = \frac{\pi}{2}$, and consequently, the time of a half-oscilla-

tion is $\sqrt{\frac{a}{g}} F\left(\sin \frac{\alpha}{2}, \frac{\pi}{2}\right)$.

Show by Table I that when $a = 36^\circ$, the time of oscillation is $1.0253 \dots$

times greater than that given by the approximate formula $t = \sqrt{\frac{a}{g}} \pi$.

The following problems taken from Byerly's Calculus are instructive:

8. A pendulum swings through an angle of 180° ; required, the time of oscillation. *Ans.* $3.708\sqrt{\frac{a}{g}}$.

9. The time of vibration of a pendulum swinging in an arc of 72° is observed to be 2 seconds; how long does it take it to fall through an arc of 5° , beginning at a point 20° from the highest point of the arc of swing? *Ans.* $0.095 \dots$ second.

10. A pendulum for which $\sqrt{\frac{a}{g}}$ is $\frac{1}{2}$, vibrates through an arc of 180° ; through what arc does it rise in the first half second after it has passed its lowest point? In the first $\frac{1}{8}$ of a second? *Ans.* 69° ; $20^\circ 6'$.

11. Show that a pendulum which beats seconds when swinging through an angle of 6° , will lose 11 to 12 seconds a day if made to swing through 8° and 26 seconds a day if made to swing through 10° .

(Simpson's *Fluxions*, § 464.)

CHAPTER VI

FIVE-PLACE TABLES

THE following tables of integrals are given in Levy's *Théorie des fonctions elliptiques*. As stated by Professor Levy, he was assisted by Professor G. Humbert in compiling these tables from the ten-place tables that are found in the second volume of Legendre's Treatise.

Table I gives values of the integrals

$$K = \int_0^{\frac{1}{2}\pi} \frac{d\phi}{\sqrt{1 - \sin^2 \theta \sin^2 \phi}} \quad \text{and} \quad E = \int_0^{\frac{1}{2}\pi} d\phi \sqrt{1 - \sin^2 \theta \sin^2 \phi}.$$

For example, if $\theta = 78^\circ 30'$, then $K = 3.01918$ and $E = 1.05024$.

Table II gives values of the integral

$$F(k, \phi) = \int_0^\phi \frac{d\phi}{\sqrt{1 - \sin^2 \theta \sin^2 \phi}}.$$

For example, if $\theta = 65^\circ$ and $\phi = 81^\circ$, then $F(k, \phi) = 1.94377$.

Table III gives values of the integral

$$E(k, \phi) = \int_0^\phi d\phi \sqrt{1 - \sin^2 \theta \sin^2 \phi}.$$

For example, if $\theta = 40^\circ$ and $\phi = 34^\circ$, then $E(k, \phi) = 0.57972$.

I.—THE COMPLETE ELLIPTIC INTEGRALS OF THE FIRST AND SECOND KINDS

θ	K	E	θ	K	E	θ	K	E
0°	1 57080	1.57080	50°	1.93558	1.30554	82° 0'	3.36987	1.02784
1	092	068	51	5386	29628	12	9457	670
2	127	032	52	7288	28695	24	3.41994	558
3	187	1.56972	53	9267	27757	36	4601	447
4	271	888	54	2.01327	26815	48	7282	338
5	370	781	55	3472	25868	83 0	3.50042	231
6	511	650	56	5706	24918	12	2884	126
7	668	495	57	8036	23966	24	5814	023
8	849	296	58	2.10466	23013	36	8837	1921
9	1 58054	114	59	3002	22059	48	3.61959	821
10	284	1.55880	60	2.15652	21106	84 0	3.65186	1.01724
11	539	640	61	8421	20154	12	8525	628
12	820	368	62	2.21319	19205	24	3.71984	534
13	1 59125	073	63	4355	18259	36	5572	443
14	457	1.54755	64	7538	17318	48	9298	354
15	814	415	65	2.30879	16383	85 0	3.83174	266
16	1.60198	052	66	4390	15455	12	7211	181
17	608	1.53667	67	8087	14535	24	3.91423	099
18	1.61045	260	68	2.41984	13624	36	5827	018
19	510	1.52831	69	6100	12725	48	4.00437	0940
20	1.62003	380	70° 0'	2.50455	11838	86 0	5276	865
21	523	1.51908	30	2729	11399	12	4.10366	792
22	1.63073	415	71 0	5073	10904	24	5736	721
23	632	1.50901	30	7490	10533	36	4.21416	653
24	1.64260	366	72 0	9982	106	48	7444	588
25	900	1.49811	30	2.62555	09683	87 0	4.33865	526
26	1.65570	237	73 0	5214	265	12	40733	466
27	6272	1.48643	30	7962	8851	24	8115	410
28	7006	029	74 0	2.70807	443	36	56190	356
29	7773	1.47397	30	3752	039	48	64765	306
30	1.68575	1.46746	75 0	6806	7641	88 0	74272	258
31	9411	077	30	9975	248	12	84785	215
32	1 70284	1.45391	76 0	2.83267	6861	24	96542	174
33	1192	44687	30	6691	480	36	5.09876	137
34	2139	43966	77 0	2.90256	106	48	25274	104
35	3125	229	30	3974	5738	89 0	43491	075
36	4150	42476	78 0	7857	378	6	54020	062
37	5217	41707	30	3.01918	024	12	65792	050
38	6326	40924	79 0	6173	4679	18	79140	049
39	7479	126	30	3.10640	4341	24	94550	030
40	1.78677	1.39314	80 0	5339	011	30	6.12778	021
41	9922	38489	12	7288	3882	36	35038	014
42	1.81216	37650	24	9280	754	42	63854	008
43	2560	36800	36	3.21317	628	48	7.04398	004
44	3957	35938	48	3400	503	54	73711	011
45	5407	35064	81 0	5530	379	90	∞	000
46	6915	34181	12	7711	257			
47	8481	33287	24	9945	126			
48	1.90108	32384	36	3.32234	017			
49	1800	31473	48	4580	2900			

II.—ELLIPTIC INTEGRALS OF THE FIRST KIND

ϕ	θ									
	0°	5°	10°	15°	20°	25°	30°	35°	40°	45°
1°	0.01745	0.01745	0.01745	0.01745	0.01745	0.01745	0.01745	0.01745	0.01745	0.01745
2	0349I	0349I	0349I	0349I	0349I	0349I	0349I	0349I	0349I	0349I
3	05236	05236	05236	05236	05236	05236	05237	05237	05237	05237
4	0698I	0698I	0698I	06982	06982	06982	06983	06983	06984	06984
5	08727	08727	08727	08727	08728	08729	08729	08730	0873I	08732
6	10472	10472	10473	10473	10474	10475	10477	10478	10480	10482
7	12217	12218	12218	12219	12221	12223	12225	12227	12230	12233
8	13963	13963	13964	13966	13968	1397I	13974	13978	1398I	13985
9	15708	15708	15710	15712	15715	15719	15724	15729	15735	15740
10	17453	17454	17456	17459	17464	17469	17475	17482	17490	17498
11	19199	19200	19202	19206	19212	19220	19228	19237	19247	19258
12	20944	20945	20949	20954	20962	20971	20982	20994	21007	21021
13	22689	22691	22695	22702	22712	22724	22738	22753	22770	22787
14	24435	24436	24442	24451	24463	24478	24495	24514	24535	24556
15	26180	26182	26189	26200	26215	26233	26254	26278	26303	26330
16	27925	27928	27936	27949	27967	27989	28015	28044	28075	28107
17	29671	29674	29684	29699	29721	29748	29779	29813	29850	29889
18	31416	31420	31431	31450	31475	31507	31544	31585	31629	31675
19	33161	33166	33179	33201	33231	33268	33312	33360	33412	33466
20	34907	34912	34927	34953	34988	35031	35082	35138	35199	35262
21	36652	36658	36676	36706	36746	36796	36855	36920	36990	37063
22	38397	38404	38425	38459	38505	38563	38630	38705	38786	38871
23	40143	40151	40174	40213	40266	40331	40408	40494	40587	40683
24	41888	41897	41924	41968	42027	42102	42189	42287	42392	42503
25	43633	43643	43674	43723	43791	43875	43973	44084	44203	44328
26	45379	45390	45424	45479	45555	45650	45761	45885	46020	46161
27	47124	47137	47174	47230	47321	47427	47551	47690	47841	48000
28	48869	48883	48925	48994	49089	49207	49345	49500	49669	49846
29	50615	50630	50677	50753	50858	50988	51142	51315	51503	51700
30	52360	52377	52428	52513	52628	52773	52943	53134	53343	53562
31	54105	54124	54181	54273	54401	54560	54747	54959	55189	55432
32	55851	55871	55933	56035	56175	56349	56555	56788	57042	57310
33	57596	57619	57686	57797	57950	58141	58367	58623	58902	59197
34	59341	59366	59439	59561	59727	59936	60183	60463	60769	61093
35	61087	61113	61193	61325	61506	61734	62003	62308	62643	62998
36	62832	62861	62948	63090	63287	63534	63827	64159	64524	64912
37	64577	64609	64702	64857	65070	65337	65655	66016	66413	66836
38	66323	66356	66457	66624	66854	67144	67487	67879	68309	68769
39	68068	68104	68213	68393	68641	68953	69324	69747	70214	70713
40	69813	69852	69969	70162	70429	70765	71165	71622	72126	72667
41	71558	71600	71726	71933	72219	72580	73010	73502	74047	74632
42	73304	73349	73483	73704	74011	74398	74860	75389	75976	76608
43	75049	75097	75240	75477	75805	76219	76714	77282	77914	78594
44	76794	76846	76998	77251	77600	78043	78573	79182	79860	80592
45	0.78540	0.78594	0.78756	0.79025	0.79398	0.79871	0.80437	0.81088	0.81815	0.82602

II.—ELLIPTIC INTEGRALS OF THE FIRST KIND

ϕ	θ								
	50°	55°	60°	65°	70°	75°	80°	85°	90°
1	0.01745	0.01745	0.01745	0.01745	0.01745	0.01745	0.01745	0.01745	0.01745
2	03491	03491	03491	03491	03491	03491	03491	03491	03491
3	05237	05238	05238	05238	05238	05238	05238	05238	05238
4	06985	06985	06986	06986	06986	06987	06987	06987	06987
5	08733	08734	08735	08736	08736	08737	08737	08738	08738
6	10483	10485	10486	10488	10489	10490	10491	10491	10491
7	12235	12238	12240	12242	12244	12246	12247	12248	12248
8	13989	13993	13997	14000	14003	14005	14007	14008	14008
9	15746	15751	15757	15761	15765	15769	15771	15772	15773
10	17505	17513	17520	17526	17532	17536	17540	17542	17543
11	19268	19278	19288	19296	19304	19310	19314	19317	19318
12	21034	21047	21059	21071	21080	21088	21094	21098	21099
13	22804	22821	22836	22851	22863	22873	22880	22885	22886
14	24578	24599	24618	24636	24652	24664	24674	24680	24681
15	26356	26382	26406	26428	26448	26463	26475	26482	26484
16	28139	28171	28200	28227	28251	28270	28284	28293	28295
17	29927	29965	30001	30034	30062	30085	30102	30112	30116
18	31721	31766	31809	31848	31881	31909	31929	31942	31946
19	33520	33574	33624	33670	33710	33742	33766	33781	33786
20	35326	35388	35447	35501	35548	35586	35615	35632	35638
21	37137	37210	37279	37342	37396	37441	37474	37494	37501
22	38956	39040	39119	39192	39255	39307	39346	39369	39377
23	40782	40878	40969	41053	41126	41186	41230	41257	41266
24	42614	42724	42829	42925	43008	43077	43128	43159	43169
25	44455	44580	44699	44808	44904	44982	45040	45075	45088
26	46304	46445	46580	46704	46812	46901	46967	47008	47021
27	48161	48320	48472	48612	48735	48835	48910	48956	48972
28	50027	50206	50377	50534	50672	50785	50870	50922	50939
29	51902	52102	52293	52470	52624	52752	52847	52905	52925
30	53787	54009	54223	54420	54593	54736	54843	54908	54931
31	55681	55928	56166	56386	56579	56739	56858	56931	56956
32	57586	57860	58123	58367	58582	58760	58893	58975	59003
33	59501	59803	60095	60365	60604	60802	60950	61042	61073
34	61427	61760	62082	62381	62646	62865	63029	63131	63166
35	63364	63730	64085	64415	64707	64950	65132	65245	65284
36	65313	65715	66104	66468	66790	67058	67260	67385	67428
37	67273	67713	68141	68540	68895	69131	69414	69552	69599
38	69246	69727	70195	70633	71023	71349	71594	71747	71799
39	71232	71756	72267	72746	73175	73533	73804	73972	74029
40	73231	73801	74358	74882	75352	75745	76043	76228	76291
41	75243	75862	76469	77041	77555	77987	78317	78517	78586
42	77269	77940	78600	79224	79786	80258	80617	80841	80917
43	79308	80035	80752	81432	82045	82562	82954	83200	83284
44	81362	82149	82926	83665	84333	84808	85229	85598	85690
45	0.83431	0.84281	0.85122	0.85925	0.86653	0.87270	0.87741	0.88037	0.88137

II.—ELLIPTIC INTEGRALS OF THE FIRST KIND

ϕ	θ									
	0°	5°	10°	15°	20°	25°	30°	35°	40°	45°
46°	0.80285	0.80343	0.80515	0.80801	0.81108	0.81701	0.82305	0.83001	0.83779	0.84623
47	82030	82092	82275	82578	82999	83535	84178	84920	85752	86656
48	83776	83841	84035	84356	84803	85371	86055	86846	87734	88701
49	85521	85590	85795	86135	86609	87211	87937	88779	89725	90759
50	87266	87339	87556	87915	88416	89054	89825	90719	91725	92829
51	89012	89088	89317	89697	90226	90901	91716	92665	93735	94912
52	90757	90838	91078	91479	92037	92750	93613	94618	95755	97007
53	92502	92587	92841	93262	93850	94603	95514	96578	97784	99115
54	94248	94337	94603	95047	95666	96458	97420	98545	99822	1.01237
55	95993	96086	96366	96832	97483	0.98317	0.99331	1.00519	1.01871	0.3371
56	97738	97836	98130	0.98618	0.99302	1.00179	1.01247	0.2499	0.3928	0.5510
57	0.99484	0.99586	0.99894	1.00406	1.01123	0.2044	0.3167	0.4487	0.5996	0.7680
58	1.01229	1.01336	1.01653	0.2194	0.2946	0.3912	0.5092	0.6481	0.8073	0.9854
59	0.2974	0.3086	0.3423	0.3984	0.4770	0.5783	0.7021	0.8482	1.0159	1.2042
60	0.4720	0.4837	0.5188	0.5774	0.6597	0.7657	0.8955	1.0490	1.2256	1.4243
61	0.6465	0.6587	0.6954	0.7566	0.8425	0.9534	1.0894	1.2504	1.4361	1.6457
62	0.8210	0.8338	0.8720	0.9358	1.0255	1.1414	1.2837	1.4525	1.6476	1.8685
63	0.9956	1.0088	1.0486	1.1151	1.2087	1.3296	1.4784	1.6552	1.8601	2.0926
64	1.1701	1.1839	1.2253	1.2945	1.3920	1.5182	1.6735	1.8586	2.0735	2.3180
65	1.3446	1.3590	1.4020	1.4740	1.5755	1.7070	1.8691	2.0626	2.2877	2.5447
66	1.5192	1.5340	1.5787	1.6536	1.7592	1.8961	2.0651	2.2672	2.5029	2.7727
67	1.6937	1.7091	1.7555	1.8333	1.9430	2.0854	2.2615	2.4724	2.7190	3.0020
68	1.8682	1.8842	1.9324	2.0130	2.1269	2.2750	2.4583	2.6782	2.9359	3.2325
69	2.0428	2.0593	2.1092	2.1928	2.3110	2.4648	2.6555	2.8846	3.1537	3.4642
70	2.2173	2.2345	2.2861	2.3727	2.4953	2.6548	2.8530	3.0915	3.3723	3.6972
71	2.3918	2.4096	2.4630	2.5527	2.6796	2.8451	3.0509	3.2990	3.5917	3.9313
72	2.5664	2.5847	2.6400	2.7328	2.8641	3.0356	3.2491	3.5070	3.8118	4.1666
73	2.7409	2.7599	2.8169	2.9129	3.0488	3.2263	3.4477	3.7155	4.0328	4.4030
74	2.9154	2.9350	2.9939	3.0930	3.2335	3.4172	3.6466	3.9244	4.2544	4.6404
75	3.0900	3.1102	3.1710	3.2733	3.4184	3.6083	3.8457	4.1339	4.4767	4.8788
76	3.2645	3.2853	3.3480	3.4535	3.6034	3.7996	4.0452	4.3437	4.6997	5.1183
77	3.4390	3.4605	3.5251	3.6339	3.7884	3.9911	4.2449	4.5540	4.9232	5.3586
78	3.6136	3.6356	3.7022	3.8143	3.9736	4.1827	4.4449	4.7647	5.1474	5.5999
79	3.7881	3.8108	3.8793	3.9947	4.1588	4.3744	4.6451	4.9757	5.3721	5.8119
80	3.9626	3.9860	4.0565	4.1752	4.3442	4.5663	4.8455	5.1870	5.5973	6.0848
81	4.1372	4.1612	4.2336	4.3557	4.5296	4.7583	5.0462	5.3987	5.8230	6.3283
82	4.3117	4.3364	4.4108	4.5362	4.7150	4.9504	5.2470	5.6106	6.0491	6.5725
83	4.4862	4.5115	4.5879	4.7168	4.9005	5.1426	5.4479	5.8228	6.2756	6.8172
84	4.6608	4.6867	4.7651	4.8974	5.0861	5.3350	5.6490	6.0352	6.5024	7.0625
85	4.8353	4.8619	4.9423	5.0781	5.2717	5.5273	5.8503	6.2478	6.7295	7.3082
86	5.0098	5.0371	5.1195	5.2587	5.4574	5.7198	6.0516	6.4605	6.9569	7.5542
87	5.1844	5.2123	5.2968	5.4394	5.6431	5.9123	6.2530	6.6734	7.1844	7.8006
88	5.3589	5.3875	5.4740	5.6200	5.8288	6.1048	6.4545	6.8864	7.4121	8.0472
89	5.5334	5.5627	5.6512	5.8007	6.0145	6.2974	6.6560	7.0994	7.6399	8.2939
90	1.57080	1.57379	1.58284	1.59814	1.62003	1.64900	1.68575	1.73125	1.78677	1.85407

II.—ELLIPTIC INTEGRALS OF THE FIRST KIND

ϕ	θ								
	50°	55°	60°	65°	70°	75°	80°	85°	90°
46°	0.85515	0.86431	0.87342	0.88213	0.89005	0.89678	0.90193	0.90517	0.90628
47	87614	88601	89585	90529	91390	92224	92687	93042	93163
48	89729	90791	91853	92875	93811	94610	95226	95614	95747
49	91860	93001	94140	95252	96267	97139	97810	98235	98381
50	94008	95232	96465	0.97660	0.98762	0.99711	1.00444	1.00909	1.01068
51	96171	97484	0.98811	1.00102	1.01297	1.02329	0.3129	0.3638	0.3812
52	0.98352	0.99759	1.01185	0.2578	0.3872	0.4995	0.5868	0.6425	0.6616
53	1.00550	1.02055	0.3587	0.5089	0.6491	0.7711	0.8665	0.9274	0.9483
54	0.2765	0.4374	0.6018	0.7637	0.9155	1.0481	1.1521	1.2188	1.2418
55	0.4998	0.6716	0.8479	1.0223	1.1865	1.3307	1.4442	1.5171	1.5423
56	0.7248	0.9082	1.0971	1.2848	1.4624	1.6190	1.7430	1.8229	1.8595
57	0.9517	1.1472	1.3404	1.5513	1.7433	1.9136	2.0488	2.1364	2.1667
58	1.1803	1.3886	1.6050	1.8220	2.0295	2.2145	2.3623	2.4582	2.4916
59	1.4108	1.6325	1.8638	2.0970	2.3212	2.5223	2.6837	2.7890	2.8257
60	1.6432	1.8788	2.1254	2.3764	2.6186	2.8371	3.0135	3.1292	3.1606
61	1.8773	2.1277	2.3916	2.6604	2.9219	3.1594	3.3524	3.4795	3.5240
62	2.1134	2.3792	2.6606	2.9490	3.2314	3.4897	3.7008	3.8407	3.8899
63	2.3513	2.6332	2.9332	3.2425	3.5473	3.8281	4.0594	4.2135	4.2679
64	2.5910	2.8898	3.2094	3.5409	3.8699	4.1753	4.4288	4.5989	4.6591
65	2.8326	3.1491	3.4893	3.8443	4.1994	4.5316	4.8098	4.9977	5.0645
66	3.0760	3.4109	3.7728	4.1529	4.5360	4.8976	5.2031	5.4112	5.4855
67	3.3212	3.6753	4.0600	4.4668	4.8800	5.2738	5.6096	5.8404	5.9232
68	3.5683	3.9423	4.3510	4.7860	5.2317	5.6606	6.0303	6.2868	6.3794
69	3.8171	4.2119	4.6457	5.1107	5.5913	6.0586	6.4661	6.7518	6.8557
70	4.0677	4.4840	4.9441	5.4410	5.9591	6.4684	6.9181	7.2372	7.3542
71	4.3200	4.7587	5.2463	5.7768	6.3352	6.8905	7.3877	7.7450	7.8771
72	4.5739	5.0359	5.5522	6.1182	6.7198	7.3256	7.8759	8.2774	8.4273
73	4.8296	5.3155	5.8618	6.4653	7.1132	7.7743	8.3844	8.8370	9.0079
74	5.0867	5.5974	6.1750	6.8180	7.5155	8.2371	8.9146	1.94267	1.96226
75	5.3455	5.8817	6.4918	7.1763	7.9269	8.7145	1.94682	2.00499	2.02759
76	5.6056	6.1682	6.8120	7.5401	8.3473	9.2073	2.00470	0.7106	0.9732
77	5.8672	6.4569	7.1356	7.9094	8.7768	1.97157	0.6520	1.4136	1.7212
78	6.1302	6.7476	7.4625	8.2840	9.2154	2.02403	1.2878	2.1644	2.5280
79	6.3943	7.0493	7.7924	8.6637	1.96630	0.7813	1.9538	2.9094	3.4040
80	6.6597	7.3347	8.1253	9.0484	2.01193	1.3390	2.6527	3.8365	4.3625
81	6.9261	7.6309	8.4609	9.4377	0.5840	1.9131	3.3866	4.7748	5.4209
82	7.1935	7.9286	8.7991	1.98313	1.0568	2.5935	4.1560	5.7954	6.6031
83	7.4618	8.2278	9.1395	2.02290	1.5371	3.1997	4.9048	6.9109	7.9422
84	7.7309	8.5281	9.4821	0.6303	2.0244	3.7309	5.8105	8.1362	2.94870
85	8.0006	8.8296	1.98264	1.0348	2.5178	4.3658	6.6935	2.94869	3.13130
86	8.2710	9.1320	2.01723	1.4421	3.0166	5.0129	7.6116	3.09782	3.5467
87	8.5418	9.4351	0.5194	1.8515	3.5198	5.6703	8.5612	2.6198	3.64253
88	8.8129	1.97388	0.8074	2.2027	4.0265	6.3357	2.95366	4.4116	4.04813
89	9.0843	2.00429	1.2161	2.6750	4.5354	7.0068	3.05304	6.3279	4.74135
90	1.93558	2.03472	2.15652	2.30879	2.50455	2.76806	3.15339	3.83174	∞

III.—ELLIPTIC INTEGRALS OF THE SECOND KIND

ϕ	θ									
	0°	5°	10°	15°	20°	25°	30°	35°	40°	45°
1	0.01745	0.01745	0.01745	0.01745	0.01745	0.01745	0.01745	0.01745	0.01745	0.01745
2	03491	03491	03491	03491	03491	03491	03490	03490	03490	03490
3	05236	05236	05236	05236	05236	05236	05235	05235	05235	05235
4	06981	06981	06981	06981	06981	06980	06980	06979	06979	06978
5	08727	08727	08726	08726	08725	08725	08744	08723	08722	08721
6	10472	10472	10471	10471	10470	10469	10467	10466	10464	10462
7	12217	12217	12216	12215	12214	12212	12210	12207	12205	12202
8	13963	13962	13961	13960	13957	13955	13951	13948	13944	13940
9	15708	15707	15706	15704	15700	15696	15692	15687	15681	15676
10	17453	17453	17451	17447	17443	17438	17431	17427	17417	17409
11	19199	19198	19195	19191	19185	19178	19169	19160	19150	19140
12	20944	20943	20939	20934	20926	20917	20906	20894	20881	20868
13	22689	22688	22683	22676	22667	22655	22641	22626	22609	22593
14	24435	24433	24427	24419	24406	24392	24374	24355	24335	24314
15	26180	26178	26171	26160	26145	26127	26106	26083	26058	26032
16	27925	27923	27914	27901	27883	27861	27836	27807	27777	27746
17	29671	29667	29658	29642	29620	29594	29563	29529	29493	29455
18	31416	31412	31401	31382	31357	31325	31289	31248	31205	31161
19	33161	33157	33143	33121	33092	33055	33012	32965	32914	32862
20	34907	34901	34886	34860	34825	34783	34733	34678	34619	34558
21	36652	36646	36628	36598	36558	36509	36451	36387	36319	36249
22	38397	38390	38370	38336	38290	38233	38167	38094	38015	37934
23	40143	40135	40111	40073	40020	39955	39880	39796	39707	39614
24	41888	41879	41852	41809	41749	41676	41590	41496	41394	41280
25	43633	43623	43593	43544	43477	43394	43298	43191	43076	42958
26	45379	45367	45333	45278	45203	45110	45002	44882	44753	44620
27	47124	47111	47074	47012	46928	46824	46703	46569	46425	46276
28	48869	48855	48813	48745	48651	48536	48402	48252	48092	47926
29	50615	50599	50553	50477	50373	50245	50097	49931	49753	49569
30	52360	52343	52292	52208	52094	51953	51788	51605	51409	51205
31	54105	54086	54030	53938	53813	53657	53476	53275	53059	52834
32	55851	55830	55768	55667	55530	55360	55161	54940	54703	54456
33	57596	57573	57506	57396	57245	57059	56842	56600	56341	56070
34	59341	59317	59243	59123	58959	58756	58520	58256	57972	57677
35	61087	61060	60980	60850	60672	60451	60194	59907	59598	59276
36	62832	62803	62716	62575	62382	62143	61864	61552	61217	60868
37	64577	64546	64452	64300	64091	63832	63530	63193	62830	62451
38	66323	66289	66188	66023	65798	65519	65193	64828	64436	64027
39	68068	68031	67923	67746	67503	67203	66851	66459	66035	65594
40	69813	69774	69658	69467	69207	68884	68506	68084	67628	67153
41	71558	71517	71392	71188	70909	70562	70157	69703	69214	68703
42	73304	73259	73126	72907	72609	72238	71804	71318	70793	70245
43	75049	75001	74859	74626	74307	73910	73464	72927	72365	71778
44	76794	76744	76592	76343	76003	75580	75085	74530	73931	73303
45	0.78540	0.78486	0.78324	0.78059	0.77697	0.77247	0.76720	0.76128	0.75489	0.74819

III.—ELLIPTIC INTEGRALS OF THE SECOND KIND

ϕ	θ								
	50°	55°	60°	65°	70°	75°	80°	85°	90°
1°	0.01745	0.01745	0.01745	0.01745	0.01745	0.01745	0.01745	0.01745	0.01745
2	03490	03490	03490	03490	03490	03490	03490	03490	03490
3	05235	05234	05234	05234	05234	05234	05234	05234	05234
4	06978	06978	06977	06977	06976	06976	06976	06976	06976
5	08720	08719	08718	08718	08717	08716	08716	08716	08716
6	10461	10459	10458	10456	10455	10454	10453	10453	10453
7	12199	12197	12195	12192	12190	12189	12188	12187	12187
8	13936	13932	13929	13925	13923	13920	13919	13918	13917
9	15670	15665	15660	15655	15651	15648	15645	15644	15643
10	17401	17394	17387	17381	17375	17371	17367	17365	17365
11	19130	19120	19110	19102	19095	19089	19084	19082	19081
12	20855	20842	20830	20819	20809	20801	20796	20792	20791
13	22576	22559	22544	22530	22518	22508	22501	22497	22495
14	24293	24272	24253	24236	24221	24209	24200	24194	24192
15	26006	25981	25957	25936	25917	25902	25891	25884	25882
16	27714	27684	27655	27629	27606	27588	27575	27567	27564
17	29418	29381	29347	29315	29288	29267	29250	29241	29237
18	31116	31073	31032	30995	30963	30937	30917	30906	30902
19	32809	32758	32710	32666	32629	32598	32575	32561	32557
20	34496	34437	34381	34330	34286	34250	34224	34207	34202
21	36178	36109	36044	35985	35934	35892	35862	35843	35837
22	37853	37773	37699	37631	37572	37525	37490	37468	37461
23	39521	39431	39345	39268	39201	39146	39106	39081	39073
24	41183	41080	40983	40895	40819	40757	40711	40683	40674
25	42838	42722	42612	42513	42426	42356	42304	42273	42262
26	44486	44355	44232	44120	44023	43944	43885	43849	43837
27	46126	45980	45842	45716	45607	45518	45453	45413	45399
28	47759	47595	47441	47301	47180	47081	47007	46962	46947
29	49383	49202	49031	48875	48740	48629	48548	48498	48481
30	51000	50799	50609	50437	50287	50165	50074	50019	50000
31	52608	52386	52177	51986	51821	51686	51586	51525	51504
32	54207	53964	53733	53524	53341	53193	53082	53015	52992
33	55798	55531	55278	55048	54848	54684	54563	54489	54464
34	57379	57087	56811	56559	56340	56161	56028	55947	55919
35	58952	58634	58332	58057	57818	57622	57477	57388	57358
36	60515	60169	59841	59541	59280	59067	58909	58811	58779
37	62068	61693	61337	61011	60727	60495	60323	60217	60182
38	63612	63206	62820	62467	62159	61907	61720	61605	61566
39	65146	64707	64290	63908	63574	63302	63099	62965	62932
40	66671	66197	65746	65334	64974	64679	64459	64324	64279
41	68185	67675	67189	66745	66356	66038	65801	65655	65606
42	69688	69140	68619	68140	67722	67379	67124	66966	66913
43	71182	70594	70034	69520	69070	68701	68426	68257	68200
44	72665	72036	71435	70884	70401	70005	69710	69527	69466
45	0.74137	0.73465	0.72822	0.72232	0.71715	0.71289	0.70972	0.70777	0.70711

III.—ELLIPTIC INTEGRALS OF THE SECOND KIND

ϕ	θ									
	0°	5°	10°	15°	20°	25°	30°	35°	40°	45°
46°	0.80285	0.80228	0.80056	0.79775	0.79390	0.78911	0.78350	0.77721	0.77040	0.76326
47	82030	81969	81787	81489	81081	80573	79977	79308	78584	77824
48	83776	83711	83518	83202	82770	82231	81599	80890	80121	79313
49	85521	85453	85249	84914	84457	83887	83217	82466	81651	80794
50	87266	87194	86979	86626	86142	85539	84832	84036	83173	82265
51	89012	88936	88709	88336	87826	87189	86442	85601	84689	83728
52	90757	90677	90438	90045	89507	88836	88048	87161	86197	85182
53	92502	92418	92166	91753	91187	90481	89650	88715	87698	86627
54	94248	94159	93895	93450	92865	92122	91248	90264	89193	88063
55	95993	95900	95622	95166	94541	93761	92843	91807	90680	89490
56	97738	97641	97350	96872	96216	95397	94433	93345	92160	90908
57	0.99484	0.99381	0.99077	0.98576	97889	97030	96019	94878	93634	92318
58	1.01229	1.01122	1.00803	1.00279	0.99560	0.98661	97602	96405	95100	93719
59	0.2974	0.2863	0.2529	0.1981	1.01229	1.00289	0.99180	97928	96560	95111
60	0.4720	0.4603	0.4255	0.3683	0.2897	0.1915	1.00756	0.99445	98013	96495
61	0.6465	0.6343	0.5980	0.5383	0.4563	0.3538	0.2327	1.00957	0.99460	97871
62	0.8210	0.8084	0.7705	0.7083	0.6228	0.5158	0.3895	0.2465	1.00900	0.99238
63	0.9956	0.9824	0.9430	0.8781	0.7891	0.6776	0.5459	0.3967	0.2334	1.00598
64	1.1701	1.1504	1.1154	1.0479	0.9553	0.8392	0.7020	0.5465	0.3762	0.1949
65	1.3446	1.3304	1.2878	1.2176	1.1213	1.0005	0.8577	0.6958	0.5183	0.3293
66	1.5192	1.5043	1.4601	1.3873	1.2871	1.1616	1.0132	0.8447	0.6599	0.4629
67	1.6937	1.6783	1.6324	1.5568	1.4529	1.3225	1.1683	0.9932	0.8009	0.5957
68	1.8682	1.8523	1.8047	1.7263	1.6185	1.4832	1.3231	1.1412	0.9413	0.7279
69	2.0428	2.0262	1.9769	1.8957	1.7839	1.6437	1.4776	1.2888	1.0812	0.8593
70	2.2173	2.2002	2.1491	2.0650	1.9493	1.8040	1.6318	1.4360	1.2205	0.9901
71	2.3918	2.3741	2.3213	2.2343	2.1145	1.9640	1.7857	1.5828	1.3594	1.1202
72	2.5664	2.5481	2.4935	2.4034	2.2796	2.1239	1.9394	1.7293	1.4977	1.2497
73	2.7409	2.7220	2.6656	2.5726	2.4446	2.2837	2.0928	1.8754	1.6356	1.3786
74	2.9154	2.8959	2.8377	2.7417	2.6094	2.4432	2.2459	2.0211	1.7731	1.5068
75	3.0900	3.0698	3.0097	2.9107	2.7742	2.6026	2.3989	2.1666	1.9101	1.6346
76	3.2645	3.2437	3.1818	3.0796	2.9389	2.7619	2.5516	2.3117	2.0467	1.7618
77	3.4390	3.4176	3.3538	3.2486	3.1035	2.9210	2.7041	2.4566	2.1830	1.8885
78	3.6136	3.5915	3.5258	3.4174	3.2680	3.0800	2.8563	2.6012	2.3189	2.0148
79	3.7881	3.7654	3.6978	3.5862	3.4325	3.2389	3.0086	2.7456	2.4544	2.1407
80	3.9626	3.9393	3.8698	3.7550	3.5968	3.3976	3.1606	2.8897	2.5897	2.2661
81	4.1372	4.1132	4.0417	3.9238	3.7611	3.5563	3.3124	3.0336	2.7246	2.3912
82	4.3117	4.2871	4.2137	4.0925	3.9254	3.7148	3.4641	3.1773	2.8594	2.5159
83	4.4862	4.4610	4.3856	4.2612	4.0896	3.8733	3.6157	3.3209	2.9939	2.6404
84	4.6608	4.6349	4.5575	4.4299	4.2537	4.0317	3.7672	3.4643	3.1282	2.7646
85	4.8353	4.8087	4.7294	4.5985	4.4178	4.1900	3.9186	3.6076	3.2623	2.8886
86	5.0098	4.9826	4.9013	4.7671	4.5819	4.3483	4.0699	3.7508	3.3963	3.0124
87	5.1844	5.1565	5.0732	4.9357	4.7459	4.5066	4.2211	3.8939	3.5302	3.1360
88	5.3589	5.3304	5.2451	5.1043	4.9100	4.6648	4.3723	4.0309	3.6640	3.2596
89	5.5334	5.5042	5.4170	5.2729	5.0740	4.8230	4.5235	4.1799	3.7977	3.3830
90	1.57080	1.56781	1.55889	1.54415	1.52380	1.49811	1.46746	1.43229	1.39314	1.35064

III.—ELLIPTIC INTEGRALS OF THE SECOND KIND

ϕ	θ								
	50°	55°	60°	65°	70°	75°	80°	85°	90°
46°	0.75599	0.74881	0.74195	0.73564	0.73010	0.72554	0.72215	0.72005	0.71934
47	77050	76285	75553	74879	74287	73800	73436	73211	73135
48	78490	77676	76896	76177	75546	75025	74636	74396	74314
49	79920	79054	78225	77459	76786	76230	75815	75558	75471
50	81338	80419	79538	78724	78007	77414	76971	76697	76604
51	82746	81772	80836	79971	79208	78578	78106	77814	77715
52	84143	83111	82120	81202	80391	79720	79218	78907	78801
53	85529	84438	83388	82415	81554	80842	80307	79976	79864
54	86904	85752	84641	83610	82698	81941	81374	81021	80902
55	88269	87052	85879	84788	83822	83020	82417	82042	81915
56	89622	88340	87101	85949	84926	84076	83436	83039	82904
57	90965	89614	88308	87092	86011	85110	84432	84010	83867
58	92297	90876	89500	88217	87075	86122	85404	84957	84805
59	93619	92125	90677	89325	88119	87112	86352	85878	85717
60	94930	93362	91839	90415	89144	88080	87276	86773	86603
61	96231	94586	92986	91488	90148	89025	88175	87643	87462
62	97521	95797	94118	92543	91132	89948	89049	88486	88295
63	0.98802	0.96996	0.95236	0.93581	0.92096	0.90848	89898	89303	89101
64	I.00072	0.98183	0.96339	0.94602	0.93041	0.91725	0.90723	0.90094	89879
65	01333	0.99358	0.97427	0.95606	0.93965	0.92580	0.91523	0.90858	90631
66	02585	I.00522	0.98502	0.96593	0.94870	0.93412	0.92297	0.91595	91355
67	03827	01674	0.99562	0.97564	0.95756	0.94222	0.93047	0.92305	92050
68	05060	02815	I.00609	0.98518	0.96622	0.95010	0.93771	0.92987	92718
69	06284	03945	01643	0.99456	0.97469	0.95775	0.94470	0.93642	93358
70	07500	05064	02664	I.00379	0.98298	0.96519	0.95144	0.94270	93969
71	08707	06173	03672	01286	0.99108	0.97240	0.95793	0.94870	94552
72	09907	07272	04668	02178	0.99900	0.97940	0.96417	0.95442	95106
73	11098	08362	05651	03056	I.00674	0.98619	0.97016	0.95987	95630
74	12283	09442	06624	03919	01431	0.99278	0.97590	0.96503	96126
75	13460	10513	07586	04769	02172	0.99916	0.98141	0.96992	96593
76	14631	11577	08537	05607	02896	I.00534	0.98667	0.97453	97030
77	15795	12632	09478	06432	03605	01133	0.99170	0.97887	97437
78	16954	13680	10410	07245	04300	01714	0.99650	0.98293	97815
79	18107	14721	11333	08047	04981	02277	I.00107	0.98671	98163
80	19255	15755	12249	08839	05648	02823	00543	0.99023	98481
81	20399	16784	13156	09621	06304	03354	00958	0.99348	98769
82	21538	17807	14057	10395	06948	03870	01354	0.99646	99027
83	22673	18825	14952	11161	07582	04372	01731	0.99920	99255
84	23805	19839	15841	11920	08207	04863	02091	I.00168	99452
85	24934	20850	16726	12673	08825	05343	02436	00394	99619
86	26061	21857	17606	13421	09435	05813	02768	00598	99256
87	27186	22862	18484	14165	10041	06277	03089	00784	99863
88	28310	23865	19359	14906	10642	06735	03401	00954	99939
89	29432	24867	20233	15645	11241	07188	03708	01113	0.99985
90	I.30554	I.25868	I.21106	I.16383	I.11838	I.07641	I.04011	I.01266	I.00000

INDEX

- Abel, Niels, 6, 7, 24, 29, 31
 Addition-Theorem, 7
 d'Alembert, Jean, 6
 Amplitude, 24
 Andoyer, H., 6
 Appell and Lacour, *Fonctions Elliptiques*, 7, 14, 21
 Arithmetico-Geometrical Mean, 78
- Bernoulli, Jacob, 6, 7
 Burnside, W. S., 54
 Byerly, *Integral Calculus*, 48, 63, 90, 91
- Calculation of elliptic functions, 33
 Calculation of elliptic function, when modulus and argument are given, 87
 Calculation of argument, when k and the function are given, 87
 Cayley, Arthur, 6, 14, 16, 28, 65, 68, 73, 76
 Clifford, W. K., 41
 Co-amplitude, 35
 Computation, see Numerical computation
 Cosine-amplitude= cn , 24
- Delta-amplitude= dn , 24
 Durège, *Elliptische Funktionen*, 59
- $E(k, \phi)$, see Integral $E(k, \phi)$
 E_1 , the complete integral, 16, 17, 81
 Tables for E_1 , 93
Elastic curves, 6, 89
 Enneper, *Elliptische Funktionen*, 8, 10, 12
 Euler, Leonhard, 7
- $F(k, h)$, see Integral $F(k, h)$
 F_1 , the complete integral, 16, 17, 81
 Tables for F_1 , 93
 Fagnano, G. C., 6, 7
 Fricke, *Elliptische Funktionen*, 8
 Functions, elliptic, 22-39
- Gauss, C. F., 78
 Graphs of the integrals of the first and second kinds, 16, 17, 18, 19, 20
 Graphs of the functions sn , cn and dn , 36, 37, 38
 Greenhill, A. G., 6, 52
 Gudermann, M., 24, 28
 Gudermannian, The, 28, 29
- Hancock, Harris, 6, 10, 15
 Hermite, Chas., 6
 Humbert, G., 92
 Hyperbola, rectification of, 6
- Infinites, 35, 36, 37, 38
 Integrals, the $F(k, \phi)$ and $E(k, \phi)$, their graphs, 15-20
 Integrals, tables for $F(k, \phi)$ and $E(k, \phi)$, 94-101
 Integral, the $\Pi(n, k, \phi)$, 15
 Integrals, the general elliptic, 9, 14
 Integrals of certain elliptic functions, 58-63
 Integrals of first kind reduced to normal form, 41-63
 Integrals, normal, 10, 15
 Integrals, of the first, second and third kinds, 9, 60

- Jacobi, C. G. J., 5, 6, 7, 24, 25, 26, 29, 31, 34, 65
 Jacobi's imaginary transformation, 25, 34
 K, K' , tables for, 93
 K, K' , the transcendents, 26
 Lacour, E, see Paul Appell
 Lagrange, Joseph L, 7, 68
 Landen, John, 68
 Landen's transformations, 65-73
 Latitude, 89
 Legendre, Adrien Marie, 5, 6, 7, 9, 10, 11, 12, 15, 21, 22, 23, 24, 61, 68, 71, 81, 82, 84, 92
 Legendre's transformation, 10-13
 Lemniscate, 7, 88
 Levy, *Fonctions elliptiques*, 21, 92
 Maclaurin, Colin, 6
 Modulus, 12
 Molk, Jules, see Jules Tannery
 Numerical computation of integrals of 1st and 2d kinds, 69-87
 Pendulum, simple, 90, 91
 Periods, 27, 31, 35-38
 Periodic functions, property of, 7, 31
 Period-parallelogram, 32
 Period-parallelogram of $sn u$, p. 35, of $cn u$, p. 37, of $dn u$, p. 38.
 Period-strip, 31
 Quadrant of lemniscate, 88; of ellipse, 89
 Rectification of ellipse, 88; of lemniscate, 88
 Reduction formulas, 59-61
 Richelot, F. S., 10
 Serret, J. A., 7
 Simpson's Fluxions, 91
 Sine-amplitude = sn , 24
 Tables of complete integrals of 1st and 2d kinds, 93
 Tables of elliptic integrals of 1st kind, 94-97
 Tables of elliptic integrals of 2d kind, 98-101
 Tables of useful integrals, 61-63
 Tannery and Molk, *Fonctions Elliptiques*, 14
 Volume common to two cylinders, 89
 Wallis's formula, 26, 60
 Weierstrass, Karl, 24, 28
 Zeroes, 35-38